



6.1 SCOPE.

6.1.1 Purpose. This section establishes the standard format for engineering drawings. By limiting a selected number of standard sizes and by including a uniform planned format, the following will be achieved:

- a. Prevention of an inventory of excessive sizes.
- b. Improved readability, because like information is placed in the same location on all drawings.
- c. Increased productivity in making reproductions.
- d. Improved and reduced filing procedures.

6.1.2 Format Requirements For "Distribution Statements And Security Classifications With Notations".

Distribution Statements shall be a part of a technical document format. Security Classifications with Notations, when required, shall also be included as part of a technical document format when documents are prepared by, or for the Department of Defense (DoD). See FIGURES 6-2, 6-3, 6-4, 6-5, and 6-6.

6.1.3 Dating Drawings. The dating of engineering drawings serves to establish the original date or base line for historical record purposes. The original date shall be retained on redrawn drawings (same number). On multiple sheet drawings, all sheets, except inch A size (comparable METRIC A4) continuation sheet shall have the same original date as on sheet 1 except for sheets added by later revisions. See PARAGRAPH 6.9.1.10 for method of specifying dates on drawings.

6.2 APPLICABLE DOCUMENTS. Note: DoD Policy Memo 05-3 "Elimination of Waivers to Cite Military Specifications and Standards in Solicitation and Contracts" has eliminated the need for waivers to use MIL-SPECS and MIL-STDS on DoD contracts. (See PREFACE 1, Section 2)

L-P-519	Plastic Sheet Tracing, Glazing, and Matte Finish
MIL-PRF-5480	Data Engineering and Technical Reproduction
MIL-I-8500	Interchangeability and Replaceability of Component Parts for Aerospace Vehicles
MIL-M-9868	Microfilming of Engineering Documents, 35mm, Requirements for (Inactive for new application after 1/6/95: Use JEDMICS)
MIL-PRF-28000	Digital Representation For Communication of Product (Supersedes MIL-D-28000)
MIL-STD-100	Engineering Drawing Practices (Use in conjunction with ASME Y14.100) (CNCLD Supsd by: ASME Y14.100 & Appendices, ASME Y14.24, Y14.34M & Y14.35M)
MIL-STD-129	Marking for Shipment and Storage
MIL-STD-882	System Safety Program Requirements
MIL-STD-1686	Electrostatic Discharge Control Program for Protection of Electrical Parts, Assemblies and Equipment (Excluding Electrically Initiated Explosive Devices) (Metric)



6.2 (Continued)

MIL-STD-1840	Automated Interchange of Technical Information
Cataloging HDBK H4/H8 H4/H8 Sect A H4/H8 Sect B	Commercial and Government Entity (CAGE) Name to Code Code to Name
MIL-HDBK-263	Electrostatic Discharge Control Handbook for Protection of Electrical and Electronic Parts, Assemblies and Equipment (Excluding Electrically Initiated Explosive Devices) (Metric)
DoD 5220.22-M	National Industrial Security Program Operating Manual
DODD 5230.24(D)	Distribution Statements on Technical Documents
DODD 5230.25(D)	Withholding of Unclassified Technical Data From Public Disclosure
ANSI N2.1	Radiation Symbol (INACTIVE)
ANSI N12.1	Fissile Material Symbol (INACTIVE)
ASME Y14.1	Decimal Inch Drawing Sheet Size and Format
ASME Y14.1M	Metric Drawing Sheet Size and Format
ASME Y14.2M	Line Conventions and Lettering
ANSI Y14.26M	Digital Representation for Communication of Product Definition Data (CNCLD: No S/S)
ASME Y14.34M	Parts Lists, Data Lists and Index Lists
ASME Y14.35M	Revision of Engineering Drawings and Associated Documents
ASME Y14.100	Engineering Drawing Practices
IPC-2221A	Generic Standard on Printed Board Design
IPC-2222	Sectional Design Standard for Rigid Organic Printed Boards
ISO 3098-2	Technical Drawings – Lettering – Part 2
ISO HDBK Vol. 1	Technical Drawings: Technical Drawings in General



6.3 DEFINITIONS.

6.3.1 Drawing Size. A letter designation used to indicate standard format sizes. Refer to FIGURE 6-1 for U.S. Drawing Size Letter Designations.

6.3.1.1. Flat Size. A term used for drawings which, due to their size, may be filed flat in commercially available drawer files.

6.3.1.2 Roll Size. A term used for drawings which, due to their size and length, are generally filed in rolled condition.

6.3.2 Multisheet Drawing. A drawing consisting of two or more sheets.

6.3.3 Book-Form Drawing. A type of multisheet drawing used for special applications, e.g., running (wire) list, specifications, processes, printed wiring details, some cable drawings, etc. and suitable for binding into book-form or loose leaf three-ring binders. Drawing size is generally limited to INCH 8 1/2 x 11 [comparable METRIC 210 x 297] and occasionally has foldouts increasing the length of the drawing by 8.50 [210] increments, e.g. 11 x 17, [297 x 420] 11 x 25.50 [297 x 630]. Foldouts should be limited to a maximum three (3) folds. Maximum total sheet length equals 34 inches [840mm].

6.3.4 Microfilm Arrowhead. Arrowheads located in the drawing margins are used to assist in drawing alignment during microfilming operation. See FIGURES 6-1, 6-5 and 6-6.

6.4 STANDARD DRAWING SHEET SIZES. Standard sheets sizes with letter size designations are listed in TABLE 6-1. These sizes are the overall dimensions of the sheet sizes including margins but do NOT include protective margins. (See PARAGRAPH 6.4.2)

6.4.1 Roll Size Drawing Lengths. Minimum and maximum lengths for roll size drawings are listed in TABLE 6-1 and segments of length are illustrated in FIGURES 6-5 and 6-6. These dimensions have been selected in recognition of microfilm frame size requirements. This permits full zones to be included in each microfilm frame and for segment match lines to always fall on a zone mark.

6.4.2 Protective Margins. For roll size drawings it is recommended that at least two (2) inches be added at both ends of the vertical margins for protection during handling and storage. Protective horizontal margins not to exceed one inch for each margin is permissible for roll size drawings. See FIGURES 6-5 and 6-6.

6.4.3 Binding Margins. When INCH "A" [METRIC "A4"] size drawings are to be bound in book-form, the binding margin may be increased to accommodate the binding or three (3) hole drilling of the page. Both margins may be increased if the drawing format is to be printed back-to-back. See FIGURES 6-22 and 6-23.

6.4.4 Drawing Materials. Unless otherwise specified by the design activity, drawing materials shall conform to the following:

- a. Masters shall be plastic sheet in accordance with L-P-519, type I or II, class 2 (.003 or .004 thick).



- b. Undimensioned drawing and printed circuit board product masters shall be in accordance with MIL-PRF-5480, Class 3 per L-P-519, type I or II, class 1 (.007 thick).
- c. Requirements for erasure, aging and paper do not apply to associated lists prepared by automatic data processing or drawings prepared by Computer Aided Drafting (CAD).
- d. Duplicate originals shall be on silver image material as specified in PARAGRAPH 6.4.4a. Duplicate originals shall not be prepared for the purpose of maintaining duplicate records. Their application is limited to:
 - (1) Establishing a new original drawing to replace an existing drawing that has become worn or is otherwise not maintainable as an original (in this case the original form from which the duplicate original is made shall be destroyed upon verification of the duplicate original).
 - (2) Providing a base drawing to serve as a point of departure upon which changes can be made to produce a new uniquely identified original drawing (in this case the original drawing and the new uniquely identified original drawing will be separately maintained in the future).

6.5 DRAWING REDUCTIONS. Use of micrographics and copy machine reduced size reproductions may be one-half or less of the original. This practice intensifies the importance of maintaining uniform drafting practices and clarity of the original.

6.6 DRAWING SIZE SELECTION.

6.6.1 Choosing The Size Of The Drawing Form. When selecting the proper size form on which to prepare an engineering drawing, the following should be considered:

6.6.1.1 Size Of Part. What is the size of the part or assembly to be drawn?

6.6.1.2 Drawing Scale. What drawing scale will best show the design clearly.

6.6.1.3 Drawing Area Available. How much drawing area will be necessary to adequately show all necessary principle and auxiliary views including dimensioning, notes, sections, etc.?

6.6.1.4 Space For Future Add-ons. Is sufficient space allotted for revisions or future add-on information?

6.6.1.5 Plan For Best Use Of Drawing Forms And Sizes. Will one drawing or a multisheet drawing be required? Are the requirements suitable for book-form? Wherever practical "D" size [Comparable METRIC "A1"] formats are recommended for multisheet drawings while the use of roll size formats should be avoided. However, when roll size is required they should comply with FIGURES 6-5 and 6-6. Use of other roll size formats should be avoided and require approval by management before using.

6.6.1.6 Continuation Sheets. Continuation Sheets of a multi-sheet drawing should be the same size as sheet one (1) except for roll size in which case the lengths may vary.



6.7 MANUALLY AND DIGITALLY-PREPARED DRAWINGS.

6.7.1 Automatic Data Drawing Sheet Size Processing Systems. In lieu of the use of preprinted formats in the preparation of drawings, automatic data processing systems and roll plotters that prepare related engineering documentation may be used if the content and format conform to the requirements of this section. In such cases the sheet sizes may be increased to accommodate machine requirements such as automatic, punched - hole paper feed.

6.7.2 Delivery of Data Other Than on Preprinted Forms Including The Documents Data. Digital Product definition data includes:

6.7.2.1 Magnetic Tape. When magnetic tape is specified as the physical media for data delivery, the magnetic tape shall conform to MIL-PRF-28000.

6.7.2.2 File Structure. Digital product data files shall conform to MIL-PRF-28000, MIL-DTL-31000C, ISO 10303 and ASME Y14.41 as applicable.

6.7.2.3 Initial Graphics Exchange Specification (IGES). IGES engineering drawing data files shall be Class II application data subsets in conformance to MIL-PRF-28000. Files shall also conform to the applicable requirements in ISO 10303 as mandated by MIL-DTL-31000C.

6.7.2.4 Raster Engineering Drawing Data Files. Raster engineering drawing data files shall be in accordance with MIL-STD-1840.

6.7.2.5 Joint Engineering Data Management Information and Control System (JEDMICS). JEDMICS is an automation of DoD's engineering data repositories and technical data libraries using optical disk technology to permanently capture and ensure the integrity of engineering data. JEDMICS provides high quality and immediately available engineering data in an electronically transportable digital standard format. JEDMICS supports the following DoD missions:

- a. Manufacture of engineering, installation, operation and maintenance of equipment.
- b. Receipt of engineering data from original equipment manufacturers.
- c. Re-engineering parts to different specifications.
- d. Preparing bid sets for spare and repair parts acquisitions and replacements.

DoD is, and has been, migrating toward the JEDMICS system since 1995 when the initial repositories became operational. These repositories are used to store, retrieve, control manage and distribute engineering data in standard digital format, including technical manuals throughout DoD. Each new or add-on contract should be thoroughly reviewed to determine if both parties (buyer/seller), in this case Government/manufacturer, have the equipment and knowledge and it is economically feasible to pursue the JEDMICS system for inclusion in the contract or purchase order. JEDMICS is commercially available for editing and converting raster images to the JEDMICS file format.

6.7.2.6 Computer-Generated Drawing File Identifiers. Computer-generated drawing files that are identified by a filename to locate the drawing's digitized file may be placed on the drawing. The location on the drawing is at the option of the design activity.



6.8 DRAWING ARRANGEMENT.

6.8.1 Arrangement Of Information On Standard Format Drawings. The locations of the title block, supplementary data blocks, parts list, general notes, etc., are shown in FIGURES 6-2 through 6-6.

Note: Block sizes and dimensions shown herein are minimum sizes.

6.8.2 Supplementary Drawing Number Blocks. Locate drawing number block in top right margin on INCH "A" [METRIC "A4"] size horizontal format and upper left margin on INCH "A" [METRIC "A4"] size vertical format. See FIGURES 6-2 and 6-3. On drawing INCH sizes "C" through "F" and "H" through "K" [METRIC "A2", "A1", "A0"], locate the drawing number in the right hand margin as shown in FIGURE 6-1. The block may be subdivided for entering the drawing revision letter. Roll size INCH drawings (G, H, J and K) [METRIC "A4 x 3" through "A4 x 9", "A1 x 3", "A1 x 4", "A0 x 2" and "A0 x 3"] shall have additional drawing number and revision letter blocks above the bottom margin and on the reverse side of both ends as shown in FIGURES 6-5 and 6-6.

6.8.2.1 Additional Supplementary Drawing Number Blocks. Additional drawing number blocks may be added within or adjacent to the margin. For example, "A", "B" and "D" [METRIC "A4", "A3", "A1"] size drawing may have a drawing number block to the right of the microfilm arrowhead in the top margin. Sizes "C", "E", "F", "H", "J" and "K" [METRIC "A2", "A0", "A1 x 3", "A1 x 4", "A0 x 2" and "A0 x 3"] may have an additional block in the right hand margin to facilitate filing microfilm prints, see FIGURES 6-1 through 6-6.

6.8.2.2 Microfilm Identification Drawing Number Blocks. On roll size drawings, Microfilm Identification Drawing Number Blocks shall be placed to the left of the Segment Match Line. See FIGURES 6-5 and 6-6.

6.8.3 Microfilm Arrowheads. Microfilm arrowheads are located as shown in FIGURE 6-1 for INCH "A" through "F" [METRIC "A4" through "A0"] sizes and FIGURES 6-4 and 6-5, for roll sizes. Note that on roll sizes the arrowheads are located midway between the segment match lines.

6.8.4 Segment Match Lines. Segment Match lines on roll size drawings are dimensionally located from the right and are used to dimensionally locate microfilm arrowheads, supplemental drawing number blocks, microfilm identification drawing number blocks and security classification blocks, when required.

6.8.5 Lettering. The size and style of lettering printed on the drawing formats shall be in accordance with ASME Y14.2M. See SECTION 3.

6.8.6 Lines. Width of lines shall be in accordance with ASME Y14.2M. When contrasting line widths are producible, the following guidelines may be used: (See SECTION 3.)

- a. Thick
 - (1) Borderline
 - (2) Outline of principal blocks
 - (3) Main division of blocks
- b. Thin
 - (1) Division of Parts List and Revision History Block
 - (2) Minor subdivisions of the Title Block and Supplementary Blocks
 - (3) Zone markers



6.8.7 Zoning. Zoning lines in the border are dimensionally located from right for each drawing size is shown in FIGURE 6-1. INCH "A" and "B" [METRIC "A4" and "A3"] sizes are not normally zoned. Zoning on "C" through "F" [METRIC "A4" through "A0"] sizes, although optional, is usually part of the preprinted format. Zoning for roll size drawings is shown in FIGURES 6-5 and 6-6.

6.8.7.1 Zones. Determine zones by extending imaginary lines from the marks in the horizontal and vertical margins. These imaginary lines create rectangular zones across the entire drawing and are used for locating sections, views, callouts, changes, etc.

6.8.7.2 Zone Locating Symbol For Single Applications. The zone locating symbol for a single cross-reference is:

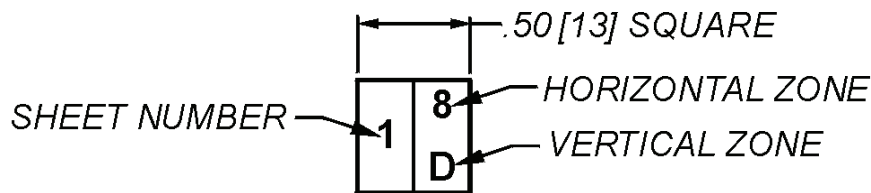

6.8.7.3 Zone Locating Symbol For Multiple Applications. The zone locating symbol for multiple cross-references is:

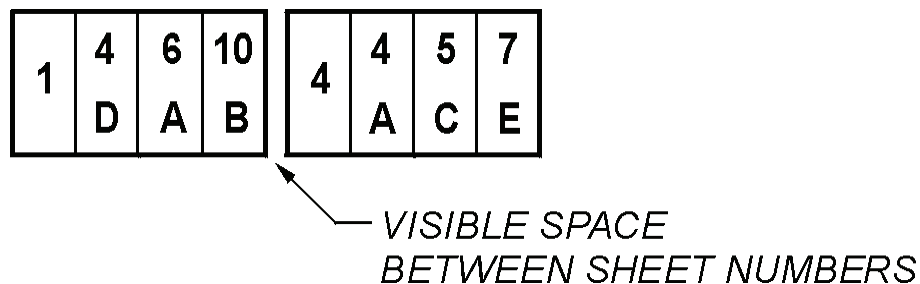

6.8.7.4 Zone Column Too Small. When the "ZONE" column is too small to identify all zones revised, the zones may be defined in the "DESCRIPTION" column and cross referenced to the zone by a flag symbol.

QTY REQD	CAGE CODE	SYM	PART OR IDENTIFYING NO.	NOMENCLATURE OR DESCRIPTION	MATERIAL SPECIFICATION	ZONE	FIND NO.
PARTS LIST							

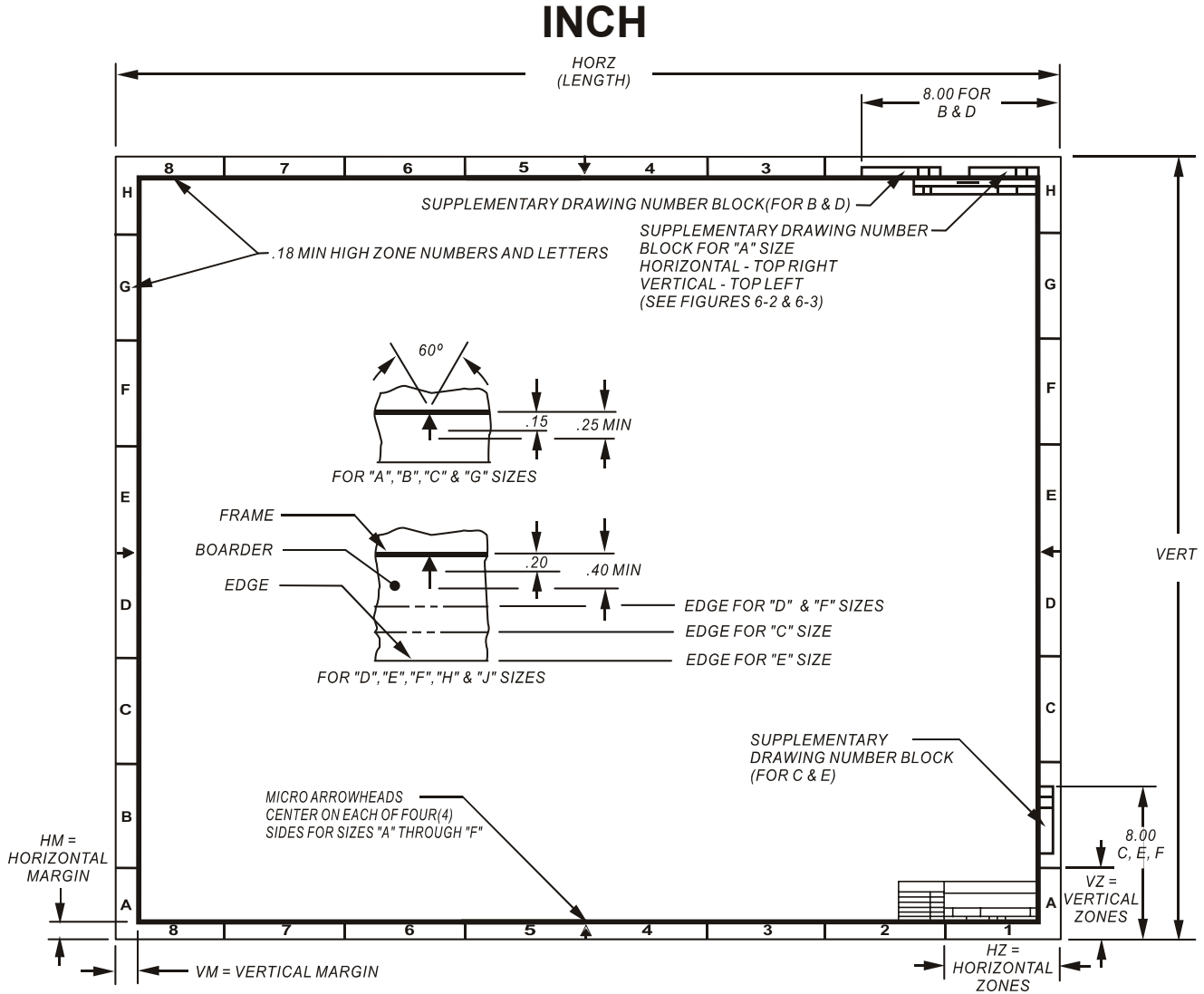

SAMPLE DECIMAL INCH DRAWING SHEET (ASME Y14.1).

FIGURE 6-1



INCH SHEET SIZES

	1st CHOICE	2nd CHOICE	HORZ (LENGTH)		VERT	MARGIN (e) (f) (g) (i)		ZONES		MICROFILM REDUCTION
						HORZ HM	VERT VM	HORZ HZ	VERT VZ	
FLAT SIZE (a)	A (HORZ) (b)	F (d)	11.0		8.5	.50	.50	2 @ 5.50	2 @ 4.25	16X
	A (VERT) (c) (h)		8.5		11.0	.50	.50	2 @ 4.25	2 @ 5.50	16X
	B (a) (d)		17.0		11.0	.50	.50	4 @ 4.25	4 @ 2.75	16X
	C (a) (d)		22.0		17.0	.50	.50	4 @ 5.50	4 @ 4.25	16X
	D (a) (d)		34.0		22.0	.50	.50	8 @ 4.25	4 @ 5.50	24X
	E (a) (d)		44.0		34.0	.50	.50	8 @ 5.50	8 @ 4.25	30X
			40.0		28.0	.50	.50	8 @ 5.00	6 @ 4.67	30X
ROLL SIZE (e) (f)	J (f)	G (e)	MIN	MAX	11.0	.50	.50	6-24 @ 3.75	4 @ 2.75	16X
			22.5	90.0						
		H (f)	44.0	143.0	28.0	.50	.50	8-26 @ 5.50	8 @ 3.50	30X
			55.0	176.0	34.0	.50	.50	10-32 @ 5.50	8 @ 4.25	30X
		K (f)	55.0	143.0	40.0	.50	.50	10-26 @ 5.50	8 @ 5.00	30X

- (a) See FIGURE 6-1
- (c) See FIGURE 6-3
- (e) See FIGURE 6-5

- (b) See FIGURE 6-2
- (d) See FIGURE 6-4
- (f) See FIGURE 6-6

(g) Protective margins not included. See PARAGRAPH 6.4.2.

(h) See FIGURE 6-24 and 6-25 for Book-Form format requirement.

(i) The margin size in TABLE 6-1 and applicable figures have been selected to permit reproduction of drawings made to these standard sizes on sheets which conform to this standard or to International paper sizes. See SECTION M5.

DECIMAL INCH DRAWING SHEET SIZES (ASME Y14.1).

TABLE 6-1



METRIC

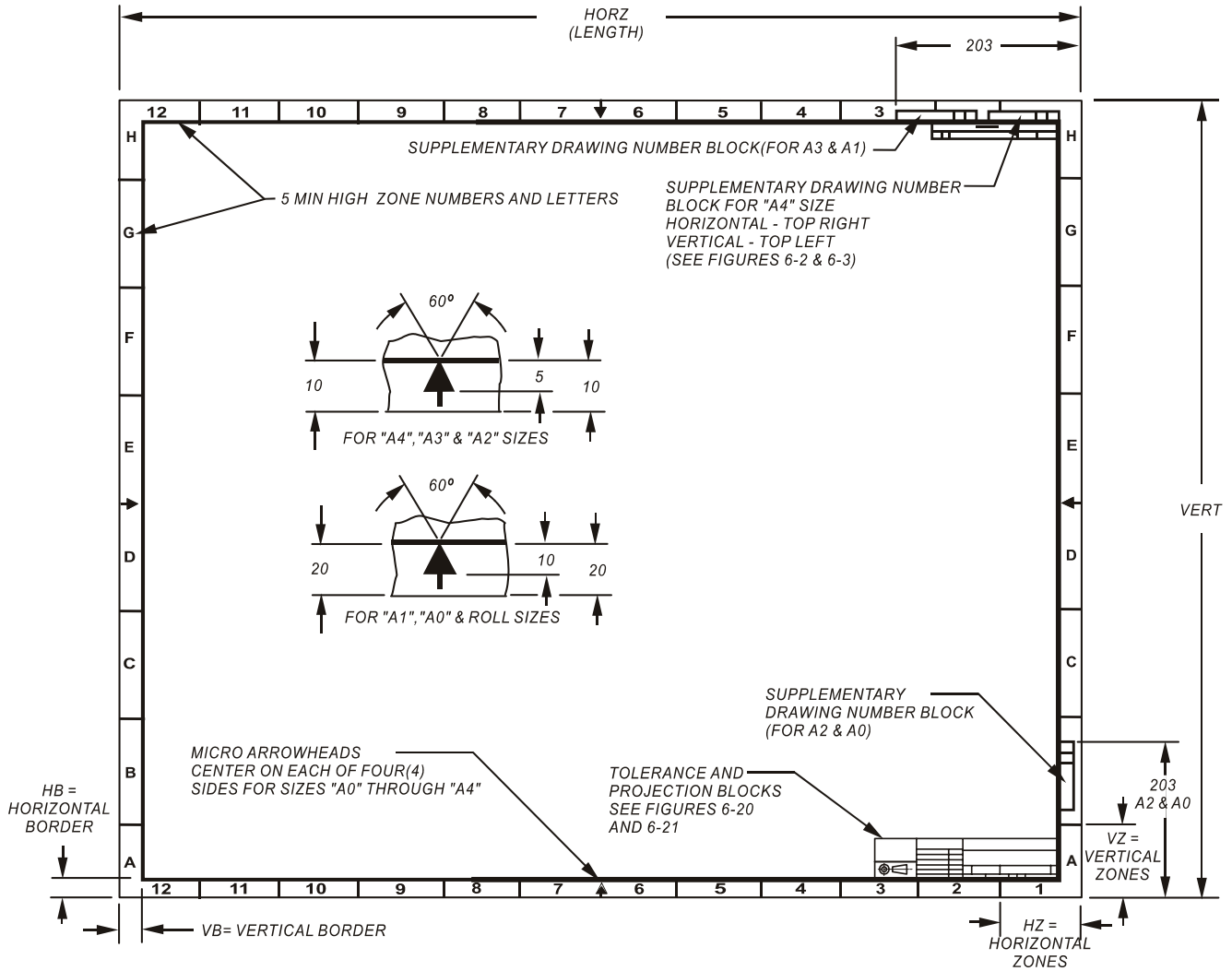

SAMPLE METRIC DRAWING SHEET (ASME Y14.1M).

FIGURE 6-1M



METRIC SHEET SIZES

METRIC SIZES(25.4) mm = 1 in.	1st CHOICE	2nd CHOICE	HORZ (LENGTH)	VERT	BORDER HB & VB	ZONES		EQUIV U.S.SIZE (INCH)	MICROFILM REDUCTION
						HORZ	VERT		
FLAT SIZE	A4 (HORZ)		297	210	10	6 @ 50	4 @ 50	A (HORZ)	16X
	A4 (VERT)		210	297	10	4 @ 50	6 @ 50	A (VERT)	16X
	A3		420	297	10	8 @ 50	6 @ 50	B	16X
	A2		594	420	10	12 @ 50	8 @ 50	C	16X
	A1		841	594	20	16 @ 50	12 @ 50	D	24X
	A0		1189	841	20	24 @ 50	16 @ 50	E	30X
** BOOK FOLDOUT		A4 X 3 (2 FOLDS)	630	297	N/A	12 @ 50	6 @ 50	G X 25.0	16X
		A4 X 4 (3 FOLDS)	841	297	N/A	16 @ 50	6 @ 50	G X 33.5	16X
METRIC SIZES(25.4) mm = 1 in.	1st CHOICE	2nd CHOICE	HORZ (LENGTH)	VERT	BORDER HB & VB	ZONES		EQUIV U.S.SIZE (INCH)	MICROFILM REDUCTION
ROLL SIZE	A3.2		594	297	10	12 @ 50	6 @ 50	B X 23.5	16X
	A3.1		841	297	10	16 @ 50	6 @ 50	B X 33.1	16X
	A3.0		1189	297	10	20 @ 50	6 @ 50	B X 46.8	16X
	A2.1		841	420	10	16 @ 50	8 @ 50	C X 33.1	16X
	A2.0		1189	420	10	24 @ 50	8 @ 50	C X 46.8	16X
	A1.0		1189	594	20	24 @ 50	12 @ 50	D X 46.8	24X

NOTES RELEVANT TO TABLE 6-1(U.S. INCH SIZES) APPLY TO TABLE 6-1M AS APPLICABLE.

* SIZES NOT RECOMMENDED.

** BOOK FOLDOUT SIZES ARE NOT SHOWN IN ASME Y14.1M-2005. THEY ARE INCLUDED HERE FOR HISTORICAL REFERENCE.

EXTRA-ELONGATED (ROLL) SIZES SHOWN IN PREVIOUS EDITION HAVE BEEN REMOVED FROM TABLE 6-1M ABOVE. ONLY STANDARD ELONGATED (ROLL) SIZES ARE INCLUDED IN AGREEMENT WITH ASME Y14.1M-2005.

METRIC DRAWING SHEET SIZES (ASME Y14.1M).

TABLE 6-1M

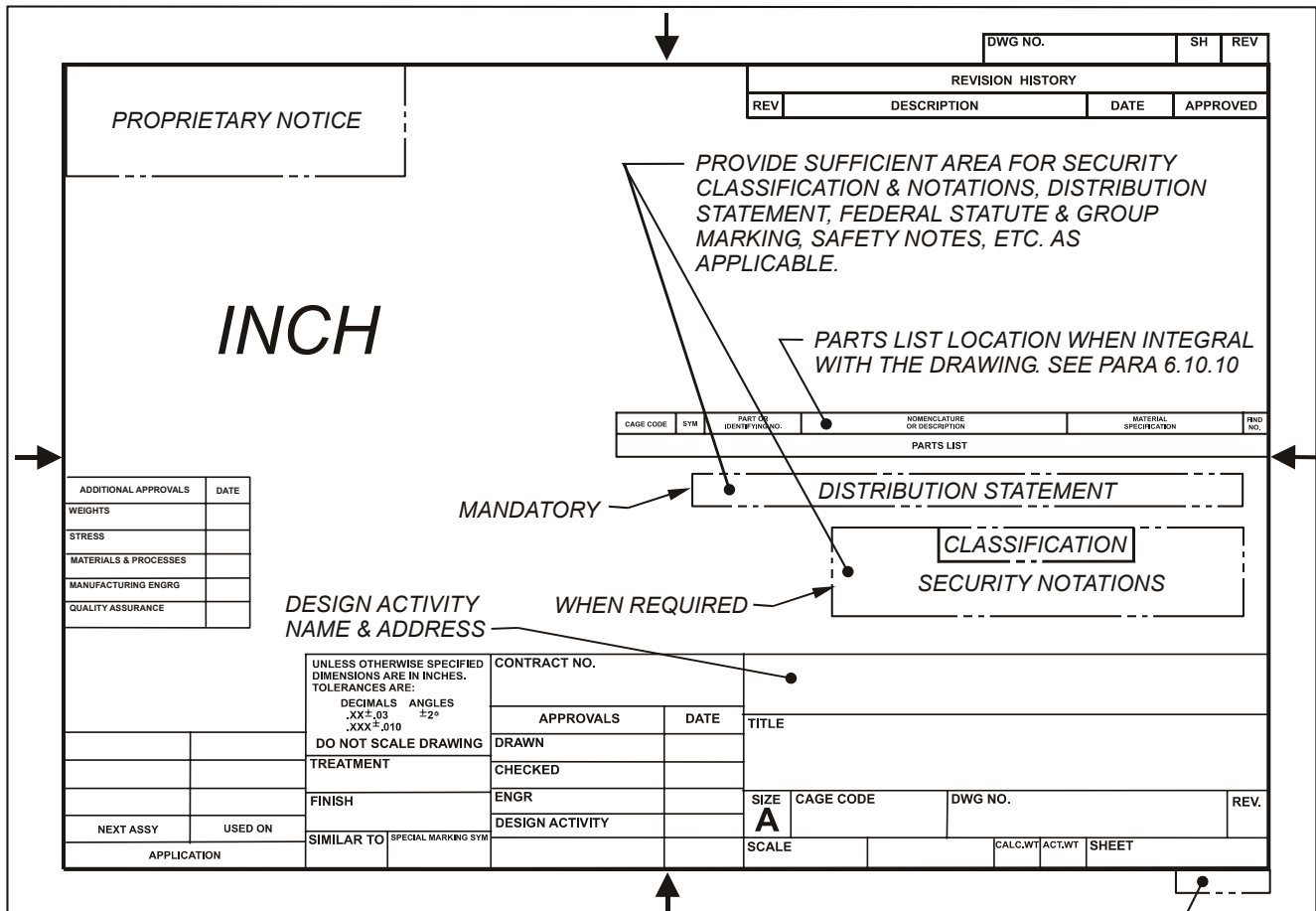

HORIZONTAL DECIMAL INCH "A" SIZE DRAWING ARRANGEMENT.

FIGURE 6-2



METRIC

		DWG. NO.		SH	REV.
REVISION HISTORY					
REV.	DESCRIPTION	DATE	APPROVED		
METRIC		TOLERANCES—MILLIMETER		CONTRACT NO.	
THIRD ANGLE PROJECTION		ON ALL HOLE DIAMETERS		APPROVALS	
		UNDER	THRU	DATE	TITLE
TREATMENT		THRU	THRU	DRAWN	
FINISH		THRU	OVER	CHECKED	
SIMILAR TO		DECIMALS	MACH.	ENGR	SIZE
ACT. WT.	CALC. WT.	X.XX ±	LDG. ±	DESIGN ACTIVITY	A4
		X.X ±	FORMED ±		CAGE CODE
		X.< ±	SHIM. ±		DWG. NO.
		X.> ±			REV.
					SCALE
					SHEET

More definitive Tolerance Block shown.
See FIGURE 6-20 for alternate Tolerance Block.

NOTE:

ALL TREATMENT RELATING TO SECURITY CLASSIFICATION, DISTRIBUTION STATEMENT, FEDERAL STATUTE & GROUP MARKING, SAFETY NOTES, PARTS LIST, REVISION BLOCK, SUPPLEMENT NUMBER BLOCK, ETC. AS APPLICABLE ARE THE SAME AS FOR "INCH" DRAWINGS.

HORIZONTAL "A4" METRIC SIZE DRAWING ARRANGEMENT.
(ALL OTHER METRIC SIZES TO RECEIVE SIMILAR TREATMENT.)

FIGURE 6-2M



REV.	APPLICATION		REVISION HISTORY			
	NEXT ASSY	USED ON	REV.	DESCRIPTION	DATE	APPROVED
SH	ADDITIONAL APPROVALS		DATE			
	WEIGHTS					
	STRESS					
	MATERIALS & PROCESSES					
	MANUFACTURING ENGRG					
	QUALITY ASSURANCE					
DWG. NO.	PROPRIETARY NOTICE		PROVIDE SUFFICIENT AREA FOR SECURITY CLASSIFICATION & NOTATIONS, DISTRIBUTION STATEMENT, FEDERAL STATUTE & GROUP MARKING, SAFETY NOTES, ETC. AS APPLICABLE			
			PARTS LIST LOCATION WHEN INTEGRAL WITH THE DRAWING SEE PARAGRAPH 6.10.10			
	CAGE CODE	SYM	PART OR IDENTIFYING NO.	NOMENCLATURE OR DESCRIPTION	MATERIAL SPECIFICATION	FIND NO.
	PARTS LIST					
	DISTRIBUTION STATEMENT					
	CLASSIFICATION					
	SECURITY NOTATIONS					
	MANDATORY WHEN REQD					
	DESIGN ACTIVITY NAME & ADDRESS					
	UNLESS OTHERWISE SPECIFIED DIMENSIONS ARE IN INCHES. TOLERANCES ARE: DECIMALS ANGLES .XX ±.01 ±2° .XXX ±.010		CONTRACT NO.		TITLE	
DO NOT SCALE DRAWING		APPROVALS	DATE			
TREATMENT		DRAWN				
		CHECKED				
FINISH		ENGR		SIZE	CAGE CODE	
		DESIGN ACTIVITY		DWG NO.	REV.	
				SCALE	SHEET	
ACCOUNTABILITY CONTROL NUMBER OR TASK CODE NUMBER WHEN APPLICABLE						

VERTICAL INCH "A" [METRIC "A4"] SIZE DRAWING ARRANGEMENT.

FIGURE 6-3

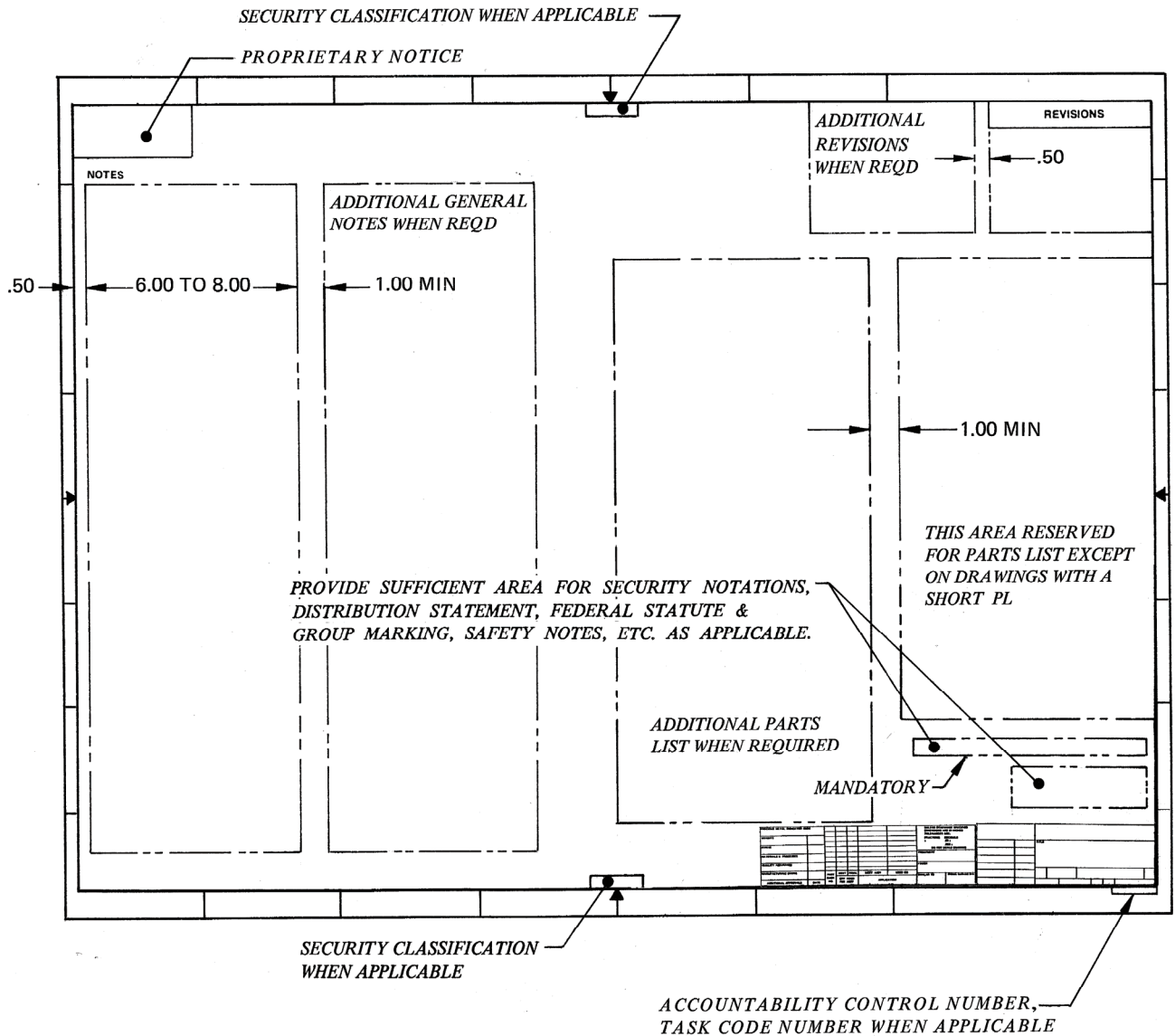

INCH	METRIC
.50	13
1.00	25
6.00 To 8.00	152 To 203

INCH "B" THRU "F" [METRIC "A3" THRU "A0"] SIZE DRAWING ARRANGEMENT.

FIGURE 6-4

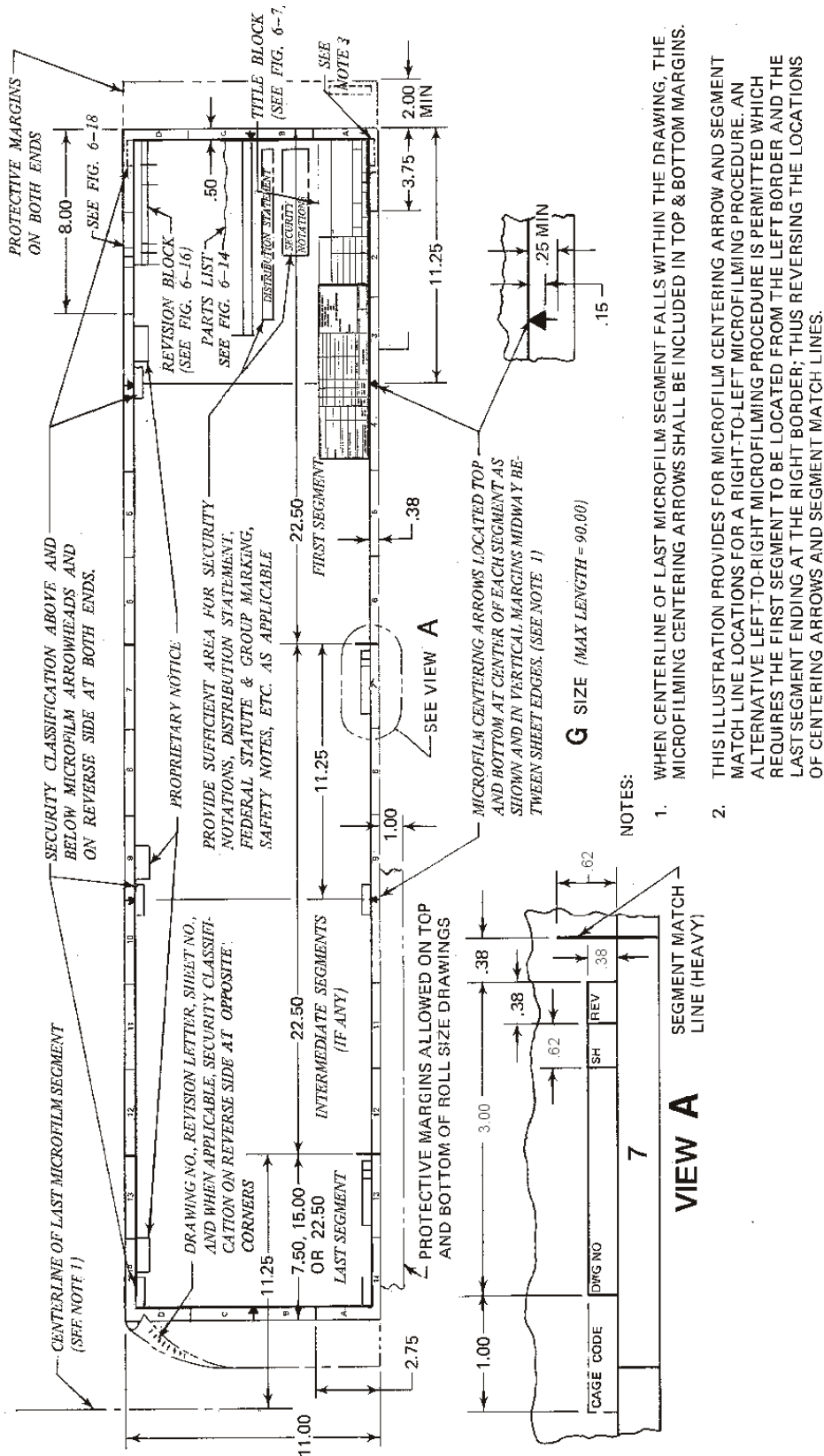

ROLL SIZE INCH DRAWING ARRANGEMENT "G" SIZE
 FIGURE 6-5

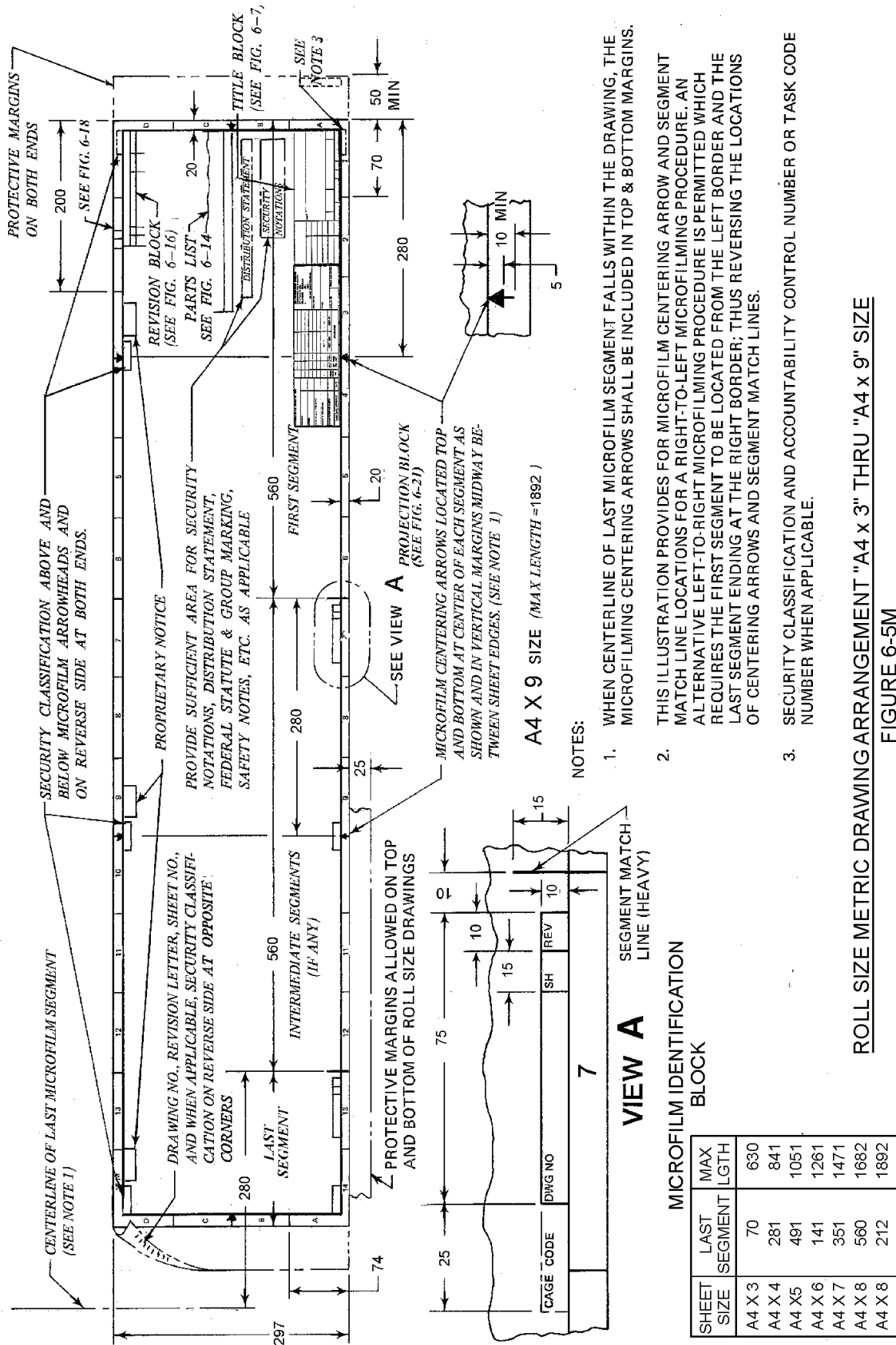

ROLL SIZE METRIC DRAWING ARRANGEMENT "A4 x 3" THRU "A4 x 9" SIZE
FIGURE 6-5M

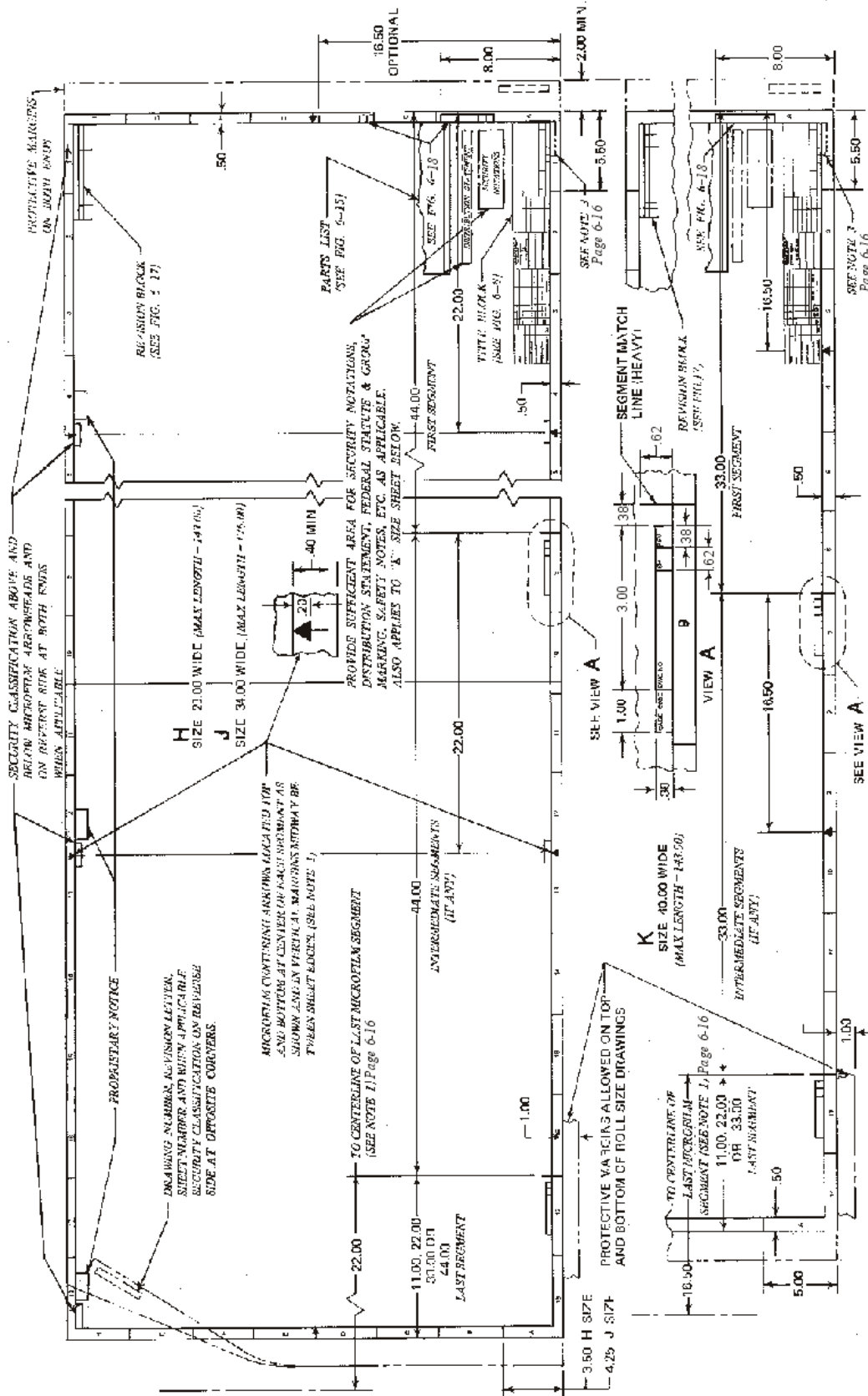

ROLL SIZE INCH DRAWING ARRANGEMENT "H", "J" AND "K" SIZES.
 FIGURE 6-6

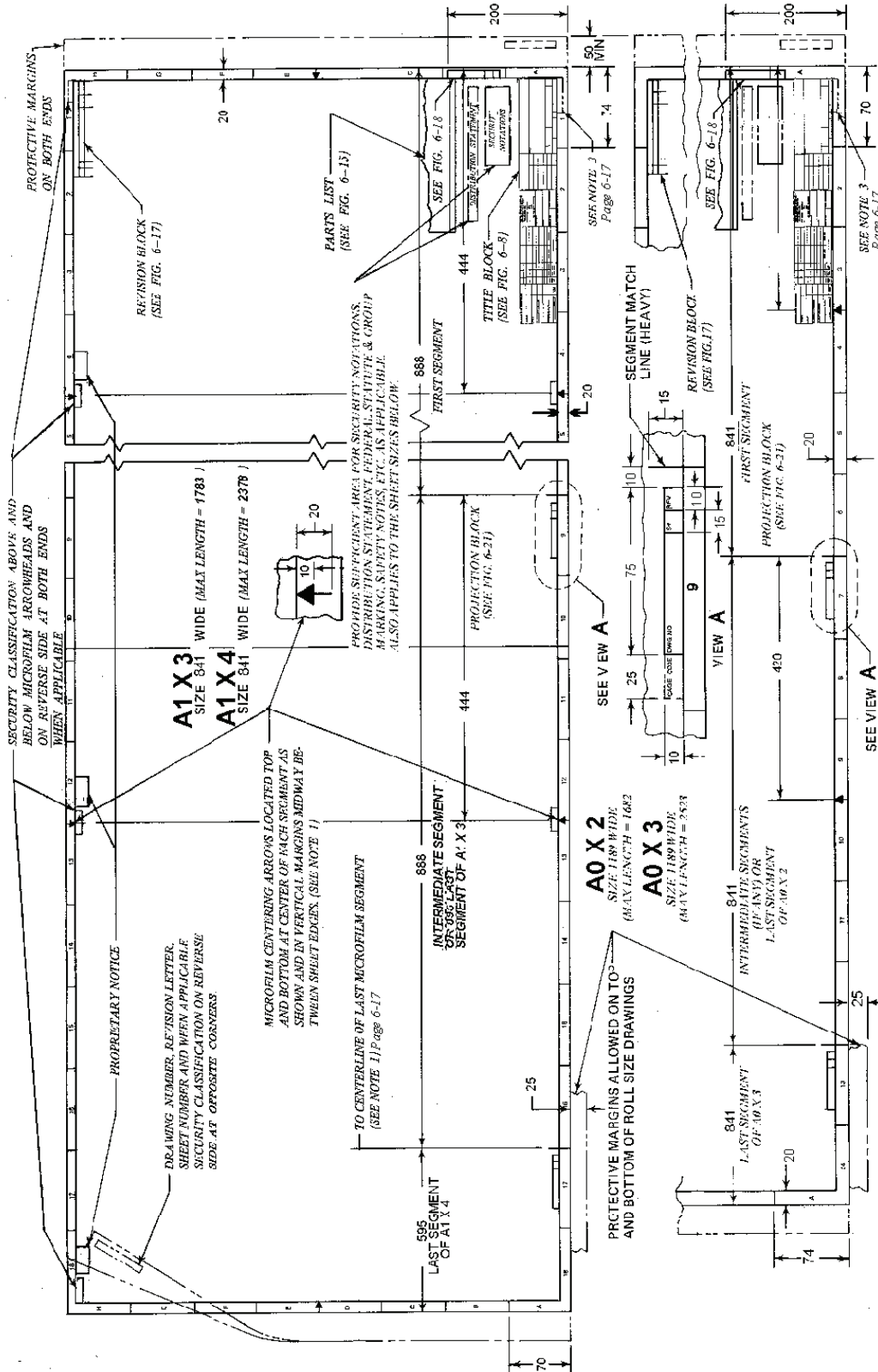

ROLL SIZE METRIC DRAWING ARRANGEMENT "A1 x 3", "A1 x 4", "A0 x 2" AND "A0 x 3" SIZES
FIGURE 6-6M



6.9 TITLE BLOCK.

6.9.1 Title Block-Format. The title block is located in the lower right hand corner of the drawing format. Entries other than signatures should be lettered by template or other mechanical means. The title block is normally preprinted as part of the drawing format on INCH "A", "B" and "C" [METRIC "A4", "A3" and "A2"] sizes and in decal form for INCH "G", "H", "J" and "K" [METRIC "A4 x 3" through "A4 x 9"] sizes. Draw a diagonal line through any preprinted portion of any block which is not used. See FIGURES 6-7 and 6-8.

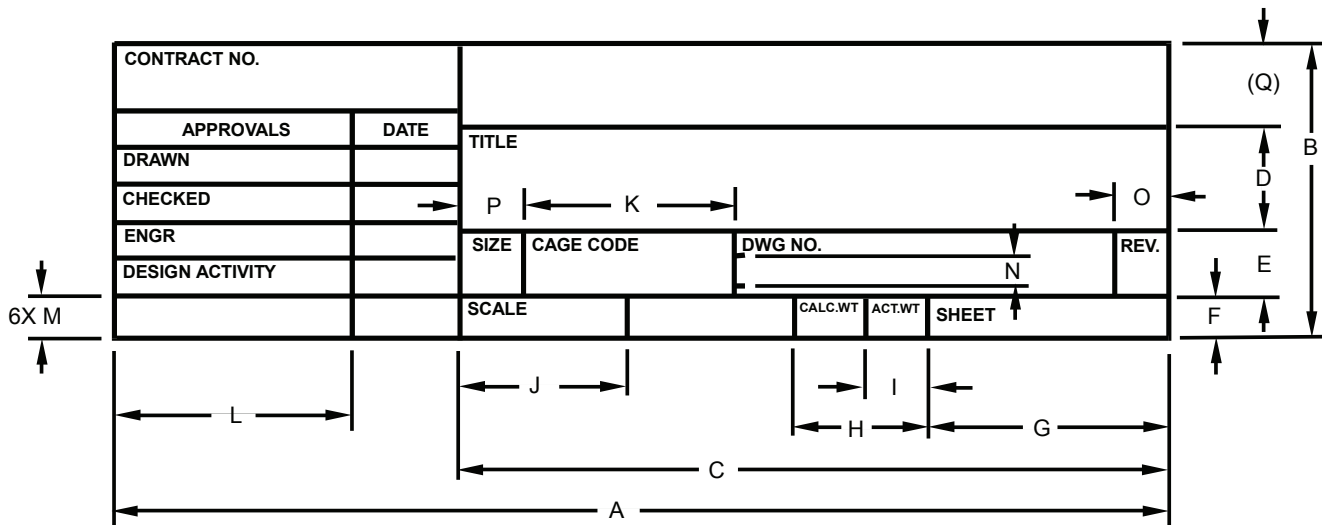

TITLE BLOCK	A	B	C	D	E	F	G	H	I	J	K	L	M	N	O	P	(Q)
INCH	6.25	2.00	4.25	.75	.38	.25	1.50	.75	.38	1.00	1.12	1.38	.22	.24	.38	.38	(.62)
*METRIC	160	54	110	20	10	6	38	20	10	25	28	35	6	6	10	10	(18)

Notes

INCH AND METRIC DIMENSION VALUES SHOWN ABOVE ARE MINIMUM VALUES.

* METRIC DIMENSIONS ARE WHOLE MILLIMETERS NOT INCH TO MILLIMETER CONVERSIONS.

INCH TITLE BLOCK FOR "A", "B", "C" AND "G" SIZES
METRIC TITLE BLOCK FOR "A4", "A3", "A2" AND "A4 x 3" THROUGH "A4 x 9" SIZES.

FIGURE 6-7

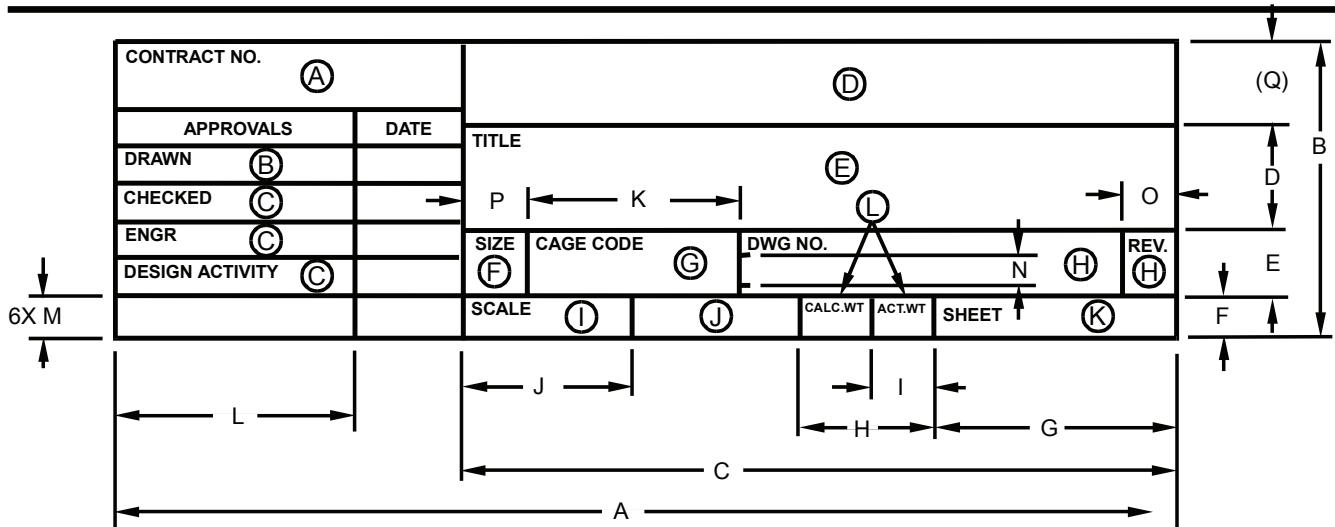

TITLE BLOCK	A	B	C	D	E	F	G	H	I	J	K	L	M	N	O	P	(Q)
INCH	7.62	2.50	5.12	1.12	.50	.25	1.75	1.00	.50	1.00	1.25	1.62	.36	.29	.50	.50	(.62)
*METRIC	200	66	135	28	14	6	45	26	13	25	32	41	8	8	14	14	(18)

INCH AND METRIC DIMENSION VALUES SHOWN ABOVE ARE MINIMUM VALUES.

* METRIC DIMENSIONS ARE WHOLE MILLIMETERS NOT INCH TO MILLIMETER CONVERSIONS.

INCH TITLE BLOCK FOR "D", "E", "F", "H", "J" AND "K" SIZES.

METRIC TITLE BLOCK FOR "A1", "A0", "A1 x 3" "A1 x 4", "A0 x 2" AND "A0 x 3" SIZES.

FIGURE 6-8

6.9.1.1 "CONTRACT NUMBER" Block. (A) Enter the contract number under which the drawing was initially prepared.

6.9.1.2 "DRAWN" Block. (B) The draftsman initials his name and the date the drawing was started. Dates shown shall be specified numerically - year, month, day, e.g. 95-04-14.

6.9.1.3. "APPROVAL" Blocks. (C) The approval blocks are signed only by authorized personnel. The "Checked" Block is initialed by the checker for the accuracy of the drawing. The "ENGR" Block is signed by the engineer responsible for the design. The DESIGN ACTIVITY Block, when required, is signed by the Design Activity representative or his designee. "DESIGN APPROVAL" Block, when required, is signed by the Government Design Activity representative or his designee. When additional approvals are required, blocks shall be added as shown in FIGURE 6-12 or 6-13. All approval signatures and initials shall be legible; initials will be accepted only for "DRAWN BY" and "CHECKER" Blocks.

6.9.1.4 "DESIGN ACTIVITY NAME AND ADDRESS" BLOCK. (D) This block contains the Company trademark and name and the design activity address.

6.9.1.5 Drawing "TITLE" Block. (E) Enter the drawing title in accordance with SECTION 8.



6.9.1.6 "SIZE" Block. (F) Enter the letter designating the drawing size.

6.9.1.7 "CAGE CODE" Number Block. (G) Enter the design activity code identification entity shown in Handbook H4/H8.

6.9.1.8 "DRAWING NUMBER" Block. (H) Enter the design activity drawing number. See SECTION 3. Inclusion of the revision symbol block is optional.

6.9.1.9 "SCALE" Block. (I) Enter drawing scale. See SECTION 3.

6.9.1.10 "RELEASE DATE" Block. (J) The Release Department enters the date the drawing is released. Dates shall be expressed numerically - year, month, day, e.g. 75-10-15.

6.9.1.11 "SHEET" Block. (K) A diagonal line is drawn through this block on single sheet drawings. See PARAGRAPH 6.9.2.12 for instructions on multisheet drawings.

6.9.1.12 "Weight" Blocks. (L) When required by contract or program instructions enter the "Actual" or "Calculated" weight, in tenths of a pound, for the item shown.

6.9.2 Continuation Sheet For Multisheet Drawings.

6.9.2.1 Multisheet Drawings Format. A continuation sheet format for sheet two and up is identical to the standard format as far as margins, zones, revision block, etc., except the supplementary data blocks shown in FIGURES 6-12 and 6-13 are omitted and the abbreviated title block shown in FIGURES 6-9 and 6-10 are used. The block size dimensions for the continuation sheet title block are the same as those for the corresponding standard format. See FIGURES 6-7 and 6-8.

6.9.2.2 Multisheet Drawing Identification. A multisheet drawing is identified with the same drawing number as sheet number one (1) and is prepared on the same format size. However, continuation sheets prepared by automated techniques need not be the same size as the first sheet.

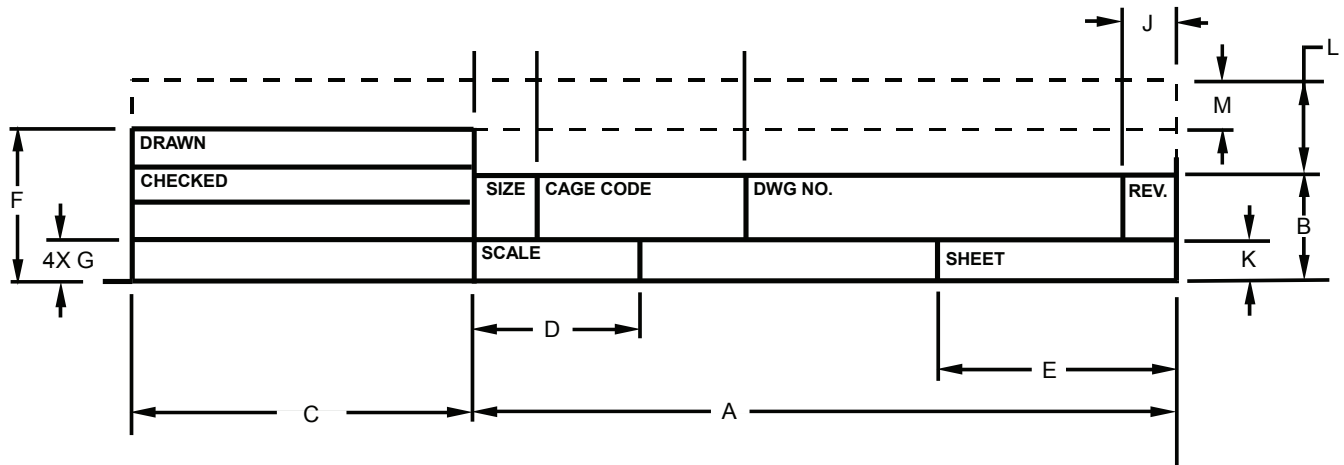

CONTINUATION TITLE BLOCK	A	B	C	D	E	F	G	H	I	J	K	L	M
INCH	4.25	.62	2.00	1.00	1.50	1.00	.25	.38	1.12	.38	.25	1.00	.56
*METRIC	110	16	50	25	45	25	6	10	29	10	6	25	14

INCH AND METRIC DIMENSION VALUES SHOWN ABOVE ARE MINIMUM VALUES.

* METRIC DIMENSIONS ARE WHOLE MILLIMETERS NOT INCH TO MILLIMETER CONVERSIONS.

INCH CONTINUATION SHEET TITLE BLOCK FOR "A", "B", "C" AND "G" SIZES.

METRIC CONTINUATION SHEET TITLE BLOCK FOR "A4", "A3", "A2" & "A4 x 3" THRU "A4 x 9" SIZES.

FIGURE 6-9

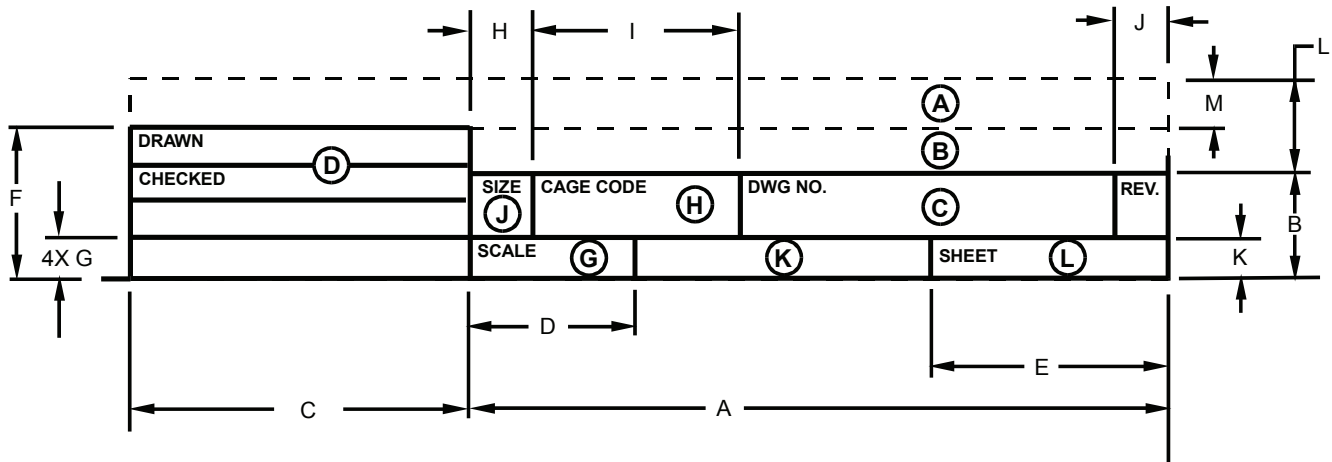

CONTINUATION TITLE BLOCK	A	B	C	D	E	F	G	H	I	J	K	L	M
INCH	5.1 2	.75	2.50	1.00	1.75	1.00	.25	.50	1.25	.50	.25	1.12	.62
*METRIC	135	20	64	25	45	24	6	14	32	14	6	29	14

INCH AND METRIC DIMENSION VALUES SHOWN ABOVE ARE MINIMUM VALUES.

* METRIC DIMENSIONS ARE WHOLE MILLIMETERS NOT INCH TO MILLIMETER CONVERSIONS.

INCH CONTINUATION SHEET TITLE BLOCK FOR "D", "E", "F", "H", "J" AND "K" SIZES.
METRIC CONTINUATION SHEET TITLE BLOCK FOR "A1", "A0", "A1 x 3", "A1 x 4", "A0 x 2" & "A0 x 3".
SIZES
FIGURE 6-10

6.9.2.3 Multisheet Title Block Entries. Sheet one (1) is prepared on standard format. The remaining sheets are prepared on standard format or on continuation sheet format. When the standard format is used for the continuation sheets, (FIGURES 6-7 or 6-8) all preprinted supplementary data and title block information is lined out except for the blocks shown in FIGURE 6-9 or 6-10. Furthermore, the "RELEASE DATE" block is left blank.

6.9.2.4 Design Activity Name And Address Block. (A) Name and address of the company whose design activity's CAGE (Commercial and Government Entity) number appears in title block. This block is optional for continuation sheets except when a CAGE Code is not used. In the absence of a CAGE Code, the design activity's name and address shall appear in this block.

6.9.2.5 Drawing "TITLE" Block. (B) This block is optional for continuation sheets.

6.9.2.6 "DRAWING NUMBER" Block. (C) Inclusion of the revision symbol block is optional for continuation sheets. The revision letter block, when used, is left blank on the initial release of continuation sheets.

6.9.2.7 Record Information Block. (D) This block contains information relative to drawing preparation, such as names, dates, drafter, checker, contract number, etc., and applies only to that specific sheet. Other blocks may be used for design activity approvals for subcontractor or other contractor approvals.



6.9.2.8 Drawing "SCALE" Block. (G) The predominant scale of the drawing is entered. Enter "NONE" when no scale is used. Each sheet may have a different predominant scale.

6.9.2.9 "CAGE CODE" Entity Block. (H) Commercial And Government Entity (CAGE) Code is inserted when required for identifying the design activity or company who issues the drawing number. This block is optional on continuation sheets.

6.9.2.10 Drawing "SIZE" Letter Identification Block. (J) This block contains the letter designating the drawing size.

6.9.2.11 Release Date Block. (K) This block is left blank on continuation sheets.

6.9.2.12 "SHEET" Block For Multiple Sheet Drawings. (L) Sheet one (1) records the sheet number and total number of sheets, e.g. 1 of 4. The continuation sheets usually record only their sheet number, e.g. 2, 3, 4, etc. The last sheet may also indicate the total number of sheets.

6.9.2.13 "REVISION" Status Of Sheets Block. The "REV STATUS OF SHEETS" block shown in FIGURE 6-11 is added to the left of the title block on sheet 1 for all formats except for INCH "A" and "B" [METRIC "A4" and "A3"] size book-form drawings. See PARAGRAPH 6.11.1.2. Sheet number blocks are added up to and including the last sheet number. The "REV" column carries a dash (-) for each sheet left originally unchanged or added as a new drawing.

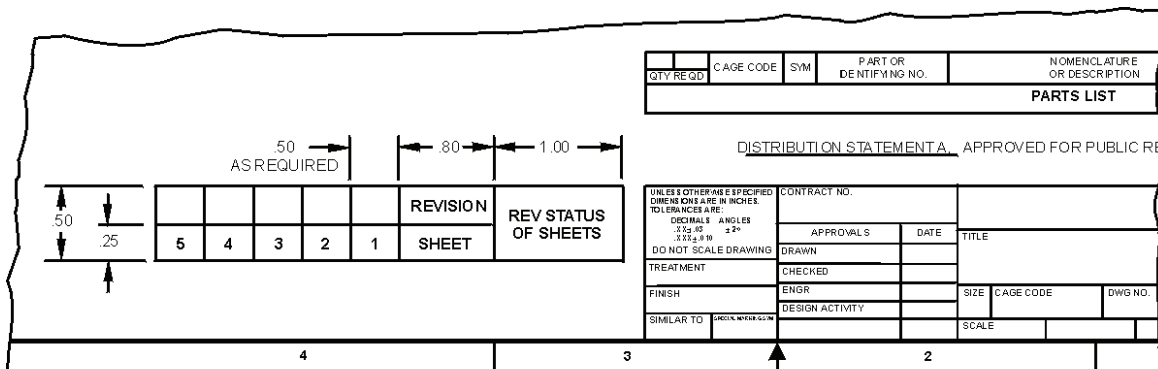

ALTERNATIVE TREATMENTS

INCH	METRIC
.25	6
.50	12
.80	20
1.00	25
1.50	38
2.00	51

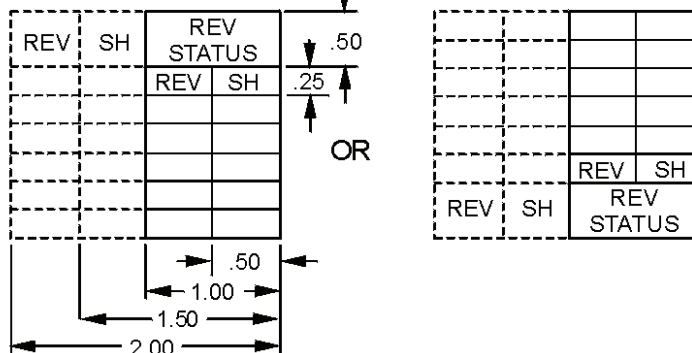

REVISION STATUS OF SHEETS BLOCK.

FIGURE 6-11



6.9.3 Parts List And General Note Location. The parts list (see FIGURES 6-2, 6-3 AND 6-4) and general notes (see SECTION 9) are placed on sheet 1 and continue for as many sheets as necessary. When the parts list extends into the general note area on sheet 1 and any subsequent sheets, the general notes must start or be indexed on the first sheet either for locating their existence or their continuation.

6.9.3.1 General Note Location On Multisheet Drawings. The beginning of all general notes must appear or be indexed on SHEET 1. They may be listed in multiple columns and space limitations may require that they be continued on another sheet.

6.9.3.1.1 Notes Continued On Subsequent Sheets. When notes are continued on another sheet, the following notation shall signify the continuation:

e.g. 23. xxxxxxxxxxxxxxxxxxxxxx etc.
LAST NOTE ON SHEET 1
NOTES CONTINUED ON SHEET 2

6.9.3.1.2 Resumed Continuation Notes On Subsequent Sheets. On the sheet/s where the notes are resumed, the numbered note shall be sequential and listed as follows:

e.g. NOTES CONTINUED FROM SHEET 1
24. xxxxxxxxxxxxxx etc.
25. xxxxxxxxxxxxxx etc.

6.9.3.1.3 General Note Has Application For Only One (or more, but less than the total sheets) Of A Multisheet Drawing. When a note has a general application for only one of a multisheet drawing, the note may be stated on that sheet and indexed in the general notes of SHEET 1.

e.g. ON SHEET 1 9. xxxxxxxxxxxxxxxxxxxxxx etc.
10. (SEE SHEET 3)
11. xxxxxxxxxxxxxxxxxxxxxx etc.

NOTES
e.g. ON SHEET 3 10. xxxxxxxxxxxxxx etc.
(SEE SHEET 1)

6.10 SUPPLEMENTARY DATA BLOCKS. (See FIGURES 6-12 AND 6-13.)

6.10.1 Supplemental Data Block Format. The area to the left of the title block is reserved for supplementary data. In addition to the items listed below, any remaining area, on drawing formats INCH "D" through "K" [METRIC "A1", "A0", and "A4" roll sizes], may be used for the tabulation of other supplementary data.

6.10.2 Re-Locating Or Restricting Use Of Supplementary Data Blocks. The supplementary data blocks are normally part of the preprinted title block format. The blocks are optional, therefore, when a block is omitted the remaining blocks are moved to the right when permitted by use of decals. When the blocks are part of the preprinted format but unused, they are lined out with a diagonal line.

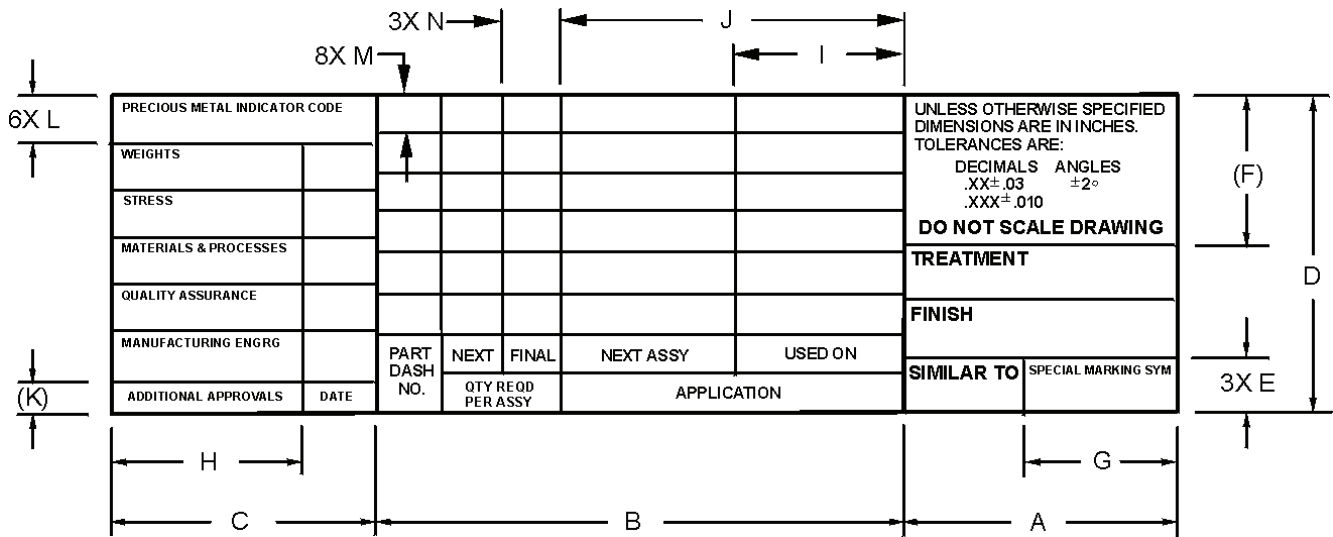

SUPPLEMENTARY DATA BLOCK	A	B	C	D	E	F	G	H	I	J	K	L	M	N
INCH	1.5 0	2.83	2.00	2.00	.36	(.92)	.75	1.50	.92	1.84	(.26)	.29	.25	.33
*METRIC	38	72	50	50	9	(23)	19	38	24	48	(8)	7	6	8

INCH AND METRIC DIMENSION VALUES SHOWN ABOVE ARE MINIMUM VALUES.

* METRIC DIMENSIONS ARE WHOLE MILLIMETERS NOT INCH TO MILLIMETER CONVERSIONS.

INCH SUPPLEMENTARY DATA BLOCK FOR "A", "B", "C" AND "G" SIZES.

METRIC SUPPLEMENTARY DATA BLOCK FOR "A4", "A3", "A2" AND "A4 x 3" THRU "A4 x 9" SIZES.

FIGURE 6-12

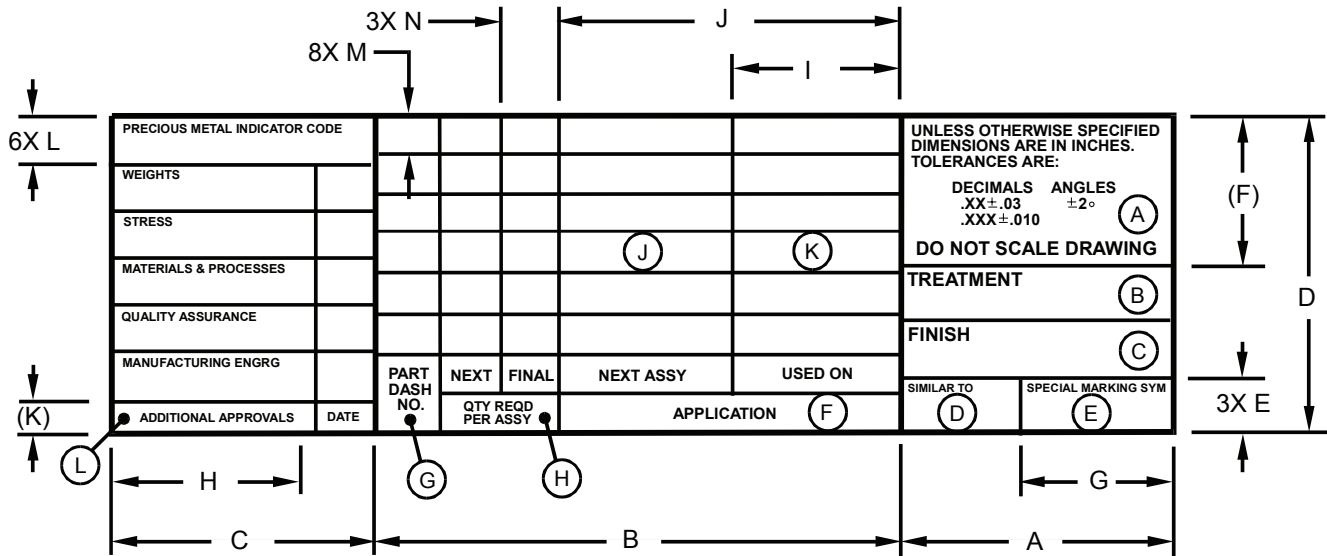

SUPPLEMENTARY DATA BLOCK	A	B	C	D	E	F	G	H	I	J	K	L	M	N
INCH	2.50	3.88	2.75	2.50	.50	(1.00)	1.30	2.00	1.25	2.50	(.25)	.38	.31	.46
*METRIC	64	98	70	64	13	(25)	33	50	32	64	(10)	9	8	11

INCH AND METRIC DIMENSION VALUES SHOWN ABOVE ARE MINIMUM VALUES.

* METRIC DIMENSIONS ARE WHOLE MILLIMETERS NOT INCH TO MILLIMETER CONVERSIONS.

INCH SUPPLEMENTARY DATA BLOCK FOR "D", "E", "F", "H", "J" AND "K" SIZES.

METRIC SUPPLEMENTARY DATA BLOCK FOR "A1", "A0", "A1 x 3", "A1 x 4" "A0 x 2" AND "A0 x 3" SIZES.

FIGURE 6-13

6.10.3 Standard Tolerance Block. (A) This block contains the standard tolerances that apply to specific dimensions as stated in SECTION 5. An angular tolerance, if not standardized and preprinted by the design activity, shall be entered when required or a dash entered to indicate the drawing contains no angular dimensions or that each angular dimension is followed by its own tolerance.

6.10.4 "TREATMENT" Block. (B) Enter the heat treatment requirements by listing the specification number and/or tensile, temper or hardness value. When additional space is needed, enter a flag note as specified in SECTION 9.

6.10.5 "FINISH" Block. (C) Enter the coating requirements as specified in SECTION 15.

6.10.6 "SIMILAR TO" Block. (D) Enter the drawing number(s) of similar parts where existing manufacturing information such as tooling, planning, etc., could be useful in making the new part.

6.10.7 "SPECIAL MARKING SYMBOLS" Block. (E) Enter the applicable symbol, e.g. HCI, HCP, or CSI, as specified in SECTION 9. When more than one is required, add a slash between symbol letters. e.g. HCI/HCP.



6.10.8 "APPLICATION" Block. (F) When the application data is maintained on the drawing, the block will be filled in as stated below. On vertical "A" size formats, the block shown in FIGURE 6-12 will be inverted and relocated as shown in FIGURE 6-3.

6.10.8.1 "PART SUFFIX IDENTIFIER (DASH) NO." Block Column. (G) Enter each Parts List suffix identifier (dash) number that is used on another drawing. The suffix identifier (dash) number is repeated for each next assembly drawing application.

6.10.8.2 "QTY REQD PER ASSY" Block Column. (H) For each suffix identifier (dash) number entry, enter the quantity used for each next assembly in the "NEXT" column and the total quantity used for each final deliverable assembly in the "FINAL" column.

6.10.8.3 "NEXT ASSY" Block Column. (J) Enter the drawing number of each next assembly. When the drawing depicts the final deliverable item, enter the word "FINAL". When the drawing is used in conjunction with other drawings, enter a flag note number and state the usage in the general notes, e.g. "THIS DRAWING IS USED IN CONJUNCTION WITH _____ (enter WIRING DIAGRAM, SCHEMATIC DIAGRAM, ASSEMBLY DRAWING, INTERCONNECTION DIAGRAM, RUNNING LIST, etc. and the drawing number).

6.10.8.4 "USED ON" Block Column. (K) Enter the model number or other designation assigned to the program.

6.10.9 "ADDITIONAL APPROVALS" Block. (L) This block is added when approvals other than those contained in the title block are required. On vertical INCH "A" [METRIC "A4"] size formats the block as shown in FIGURE 6-12 may be inverted as shown in FIGURE 6-3.



6.10.10 PARTS LIST (PL). (See FIGURES 6-14 and 6-15.)

6.10.10.1 Parts List Format. The Parts List Format is either part of the preprinted title block format or decal form and is prepared in accordance with ASME Y14.34M and applied as described in SECTION 10. Additional columns such as zone, unit weight, etc., may be added to the left of the find number column when required.

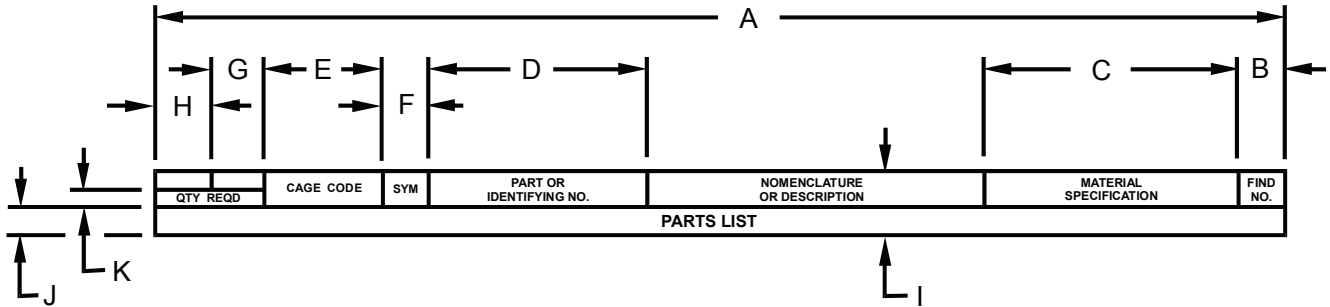

PARTS LISTS	A	B	C	D	E	F	G	H	I	J	K
INCH	7.75	.31	1.75	1.38	.81	.31	.38	.38	.63	.25	.18
*METRIC	197	8	44	35	20	8	10	10	16	6	5

INCH AND METRIC DIMENSION VALUES SHOWN ABOVE ARE MINIMUM VALUES.

* METRIC DIMENSIONS ARE WHOLE MILLIMETERS NOT INCH TO MILLIMETER CONVERSIONS.

INCH PARTS LIST BLOCK FOR "A", "B", "C" AND "G" SIZES.

METRIC PARTS LIST BLOCK FOR "A4", "A3", "A2" AND "A4 x 3" THRU "A4 x 9" SIZES.

FIGURE 6-14

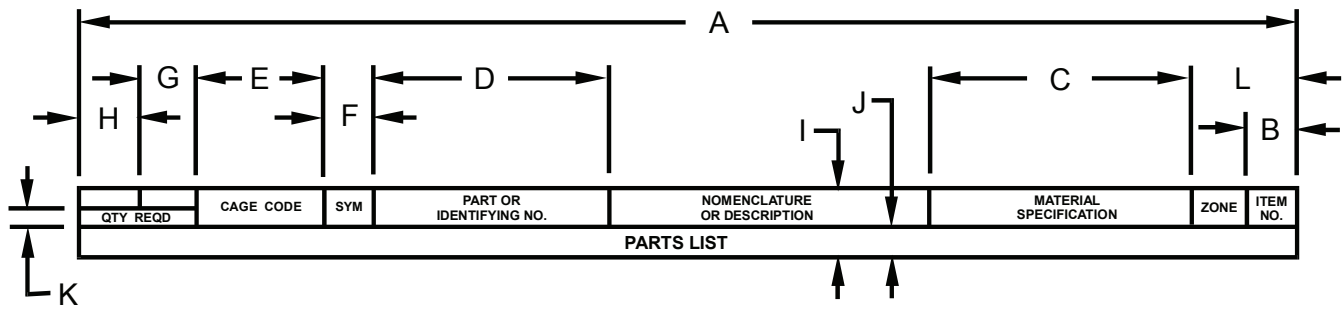

PARTS LISTS	A	B	C	D	E	F	G	H	I	J	K	L
INCH	10.12	.31	2.25	1.62	.88	.38	.38	.38	.63	.25	.18	.81
*METRIC	260	8	57	41	22	10	10	10	16	6	5	21

INCH AND METRIC DIMENSION VALUES SHOWN ABOVE ARE MINIMUM VALUES.

* METRIC DIMENSIONS ARE WHOLE MILLIMETERS NOT INCH TO MILLIMETER CONVERSIONS.

INCH PARTS LIST BLOCK FOR "D", "E", "F", "H", "J" AND "K" SIZES.

METRIC PARTS LIST BLOCK FOR "A1", "A0", "A1 x 3", "A1 x 4" "A0 x 2" AND "A0 x 3" SIZES.

FIGURE 6-15

6.10.11 Revision History Block. (See FIGURE 6-16 and 6-17.)

6.10.11.1 Revision History Block Format. The Revision History Block Format is prepared in accordance with ASME Y14.1 and ASME Y14.1M. It is normally preprinted as part of the drawing format on INCH "A" through "F" [METRIC "A0" through "A4"] sizes and in decal form for roll sizes. The entries in this block are made in accordance with ASME Y14.35M and applied as described in SECTION 23.

6.10.11.2 Revision History Block Location. The revision history block is located in the upper right corner of the drawing as shown in FIGURE 6-4. Revision history blocks may be included on continuation sheets.

NOW	WAS	WAS
ASME Y14 .35M-1997 (R2008)	ASME Y14.35M –1992 & MIL-STD-100F-1991	MIL-STD-100E SEPT 1992 INCLUDING INT. NOT. 1 & NOT. 2

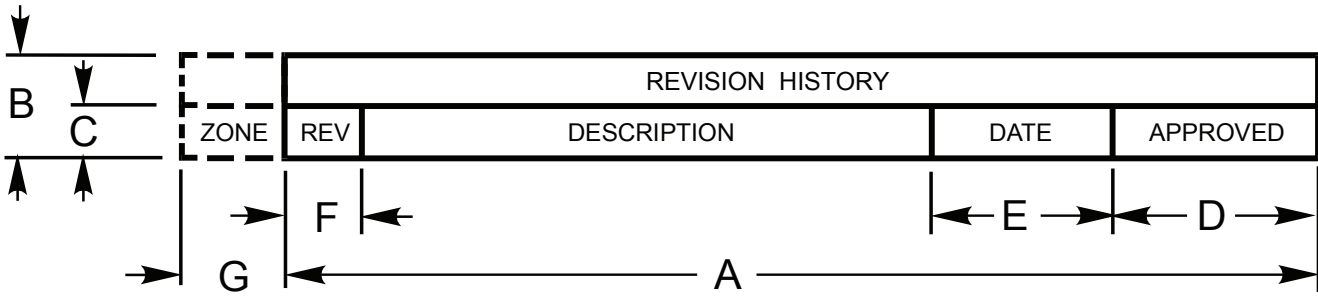

REVISION HISTORY	A	B	C	D	E	F	G
INCH	5.00	.50	.25	1.20	1.20	.40	.60
*METRIC	127	12	6	30	30	10	16

INCH AND METRIC DIMENSION VALUES SHOWN ABOVE ARE MINIMUM VALUES.

* METRIC DIMENSIONS ARE WHOLE MILLIMETERS NOT INCH TO MILLIMETER CONVERSIONS.

INCH REVISION HISTORY BLOCK FOR "A", "B", "C" AND "G" SIZES.

METRIC REVISION HISTORY BLOCK FOR "A4", "A3", "A2" AND "A4 x 3" THRU "A4 x 9" SIZES.

FIGURE 6-16

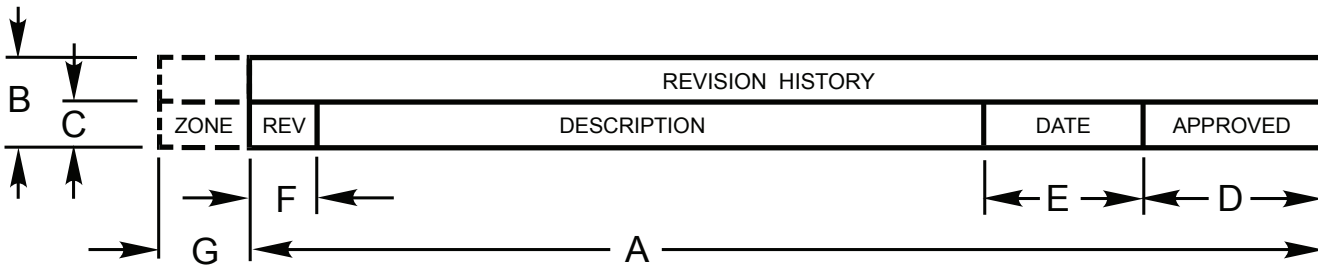

REVISION HISTORY	A	B	C	D	E	F	G
INCH	6.50	.50	.25	1.20	1.20	.40	.60
*METRIC	165	12	6	30	30	10	16

INCH AND METRIC DIMENSION VALUES SHOWN ABOVE ARE MINIMUM VALUES.

* METRIC DIMENSIONS ARE WHOLE MILLIMETERS NOT INCH TO MILLIMETER CONVERSIONS.

INCH REVISION HISTORY BLOCK FOR "D", "E", "F", "H", "J" AND "K" SIZES.

METRIC REVISION HISTORY BLOCK FOR "A1", "A0", "A1 x 3", "A1 x 4" "A0 x 2" AND "A0 x 3" SIZES.

FIGURE 6-17



6.10.11.2 Aperture Card Signature and Revision History Block. An example of original signature and revision history block entries to be made on the back of a master silver microfilm aperture card, reflecting CAD maintained database without an electronic authorization and approval system is shown in FIGURE 6-17.1. Subsequent generations may indicate printed initials and names of those who signed the first generation aperture card. The BLOCK may be applied by:

- a. Preprinting the reverse side of the aperture card
- b. Rubber stamping
- c. Decal, but only if applied before key punching, so it does not obstruct key punch holes

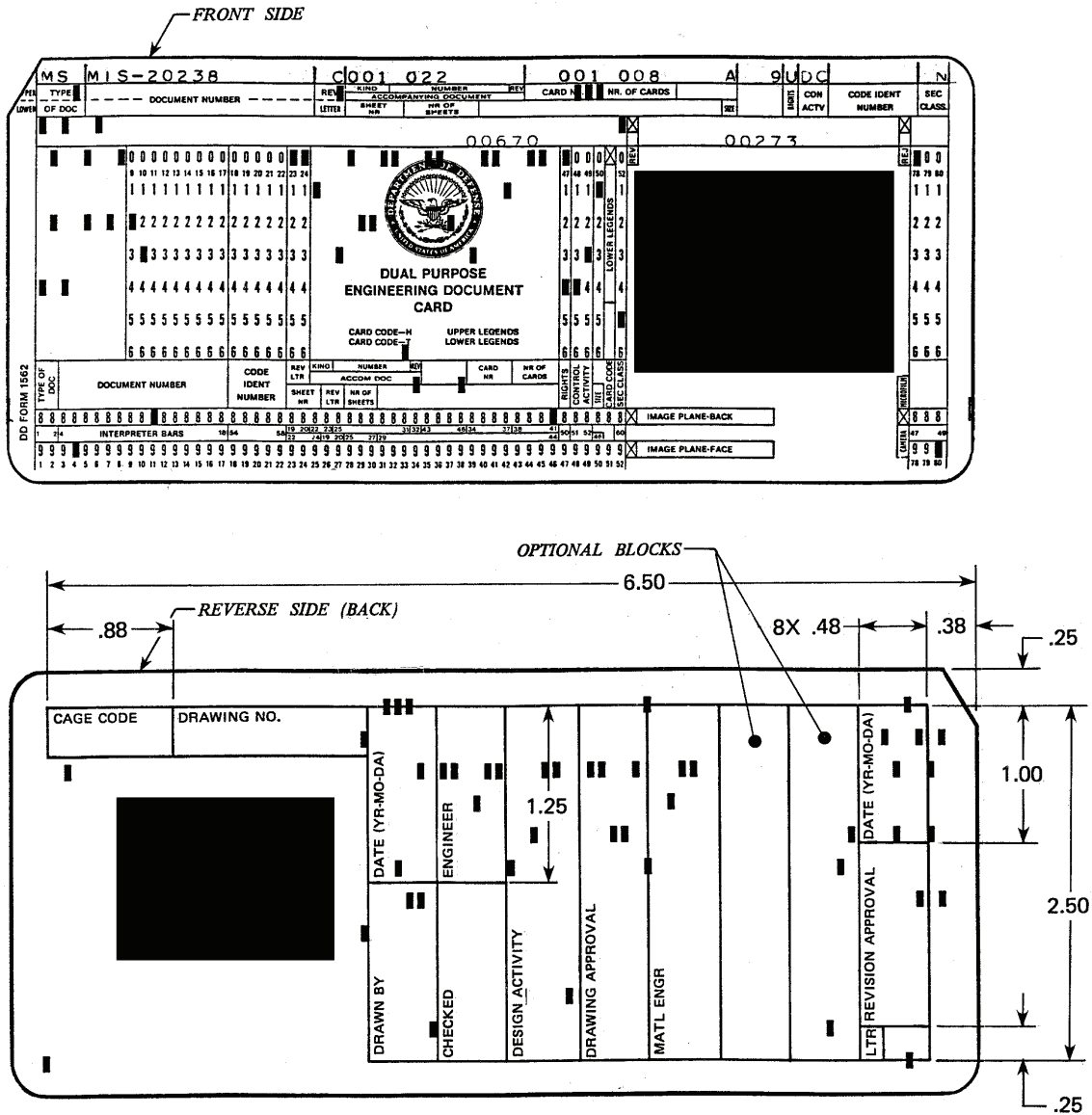

APERTURE CARD SIGNATURE AND REVISION HISTORY BLOCK.

FIGURE 6-17.1



6.10.12 Drawing Number Blocks. Drawing numbers are shown on all drawings in the title block and at least one other location on the drawing.

6.10.12.1 Drawing Number Location In Title Block. Drawing numbers are located in the lower right corner of the title block as shown in FIGURES 6-2, 6-3, 6-5 and 6-6.

6.10.12.2 Drawing Number Location Elsewhere On Drawing. Drawing numbers located outside of the title block are shown in FIGURES 6-1, 6-2, 6-3, 6-5 and 6-6.

6.10.13 Drawing Number Supplementary Blocks Format. For block sizes see FIGURES 6-18 and 6-19. They are normally preprinted on flat size sheets or INCH sizes "A" thru "F" [METRIC "A0" through "A4"] and on decals for INCH "G" thru "K" [METRIC "A4", "A1 x 3" and "A1 x 4"] roll sizes.

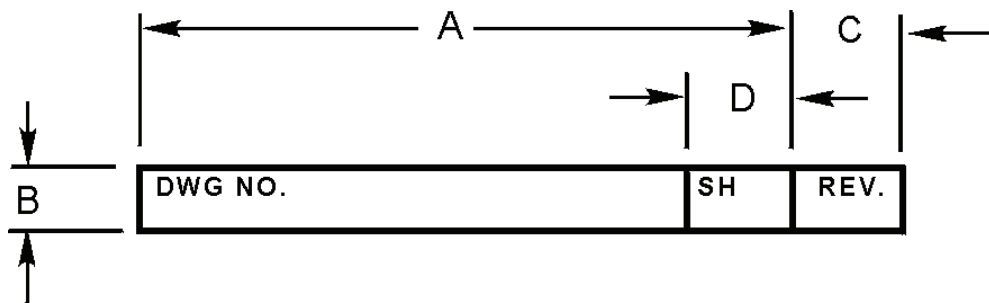

MARGIN DWG NO. BLOCK	A	B	C	D
INCH	2.38	.25	.38	.38
*METRIC	6	6	10	10

INCH AND METRIC DIMENSION VALUES SHOWN ABOVE ARE MINIMUM VALUES.

* METRIC DIMENSIONS ARE WHOLE MILLIMETERS NOT INCH TO MILLIMETER CONVERSIONS.

INCH MARGIN DWG NO. BLOCK FOR "A", "B", "C" AND "G" SIZES.

METRIC MARGIN DWG NO. BLOCK FOR "A4", "A3", "A2" AND "A4 x 3" THRU "A4 x 9" SIZES.

FIGURE 6-18

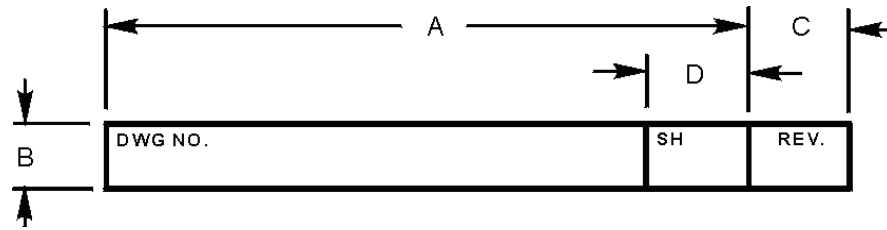

MARGIN DWG NO. BLOCK	A	B	C	D
INCH	3.25	.38	.50	.50
*METRIC	83	10	13	13

INCH AND METRIC DIMENSION VALUES SHOWN ABOVE ARE MINIMUM VALUES.

* METRIC DIMENSIONS ARE WHOLE MILLIMETERS NOT INCH TO MILLIMETER CONVERSIONS.

INCH MARGIN DWG NO. BLOCK FOR "D", "E", "F", "H", "J" AND "K" SIZES.

METRIC MARGIN DWG NO. BLOCK FOR "A1", "A0", "A1 x 3", "A1 x 4", "A0 x 2" AND "A0 x 3" SIZES.

FIGURE 6-19

6.10.14 Microfilm Identification Block Format. On roll size drawings, microfilm identification blocks shall be used and positioned at the left side of each microfilm segment match line and within the boarder as shown in FIGURES 6-5 and 6-6 [6-5M and 6-6M]. When required, the CAGE Code block shall be located to the left and adjacent to the microfilm identification block.

6.10.15 Segment Match Lines. Segment match lines are placed on roll size drawings to facilitate matching multiple segments after reproduction from the microfilm. They are located on the drawing adjoining the margin of the drawing as shown in FIGURES 6-5 and 6-6 [6-5M and 6-6M].



6.10.16 Dimensioning and Tolerancing Block Format. Dimensions shown on the drawing without tolerance are controlled by the standard tolerance in the dimensioning and tolerancing block located directly adjacent to the Title Block. This block as shown in FIGURE 6-20 may be a part of the Supplementary Data Block format shown in FIGURES 6-4, 6-12 and 6-13.

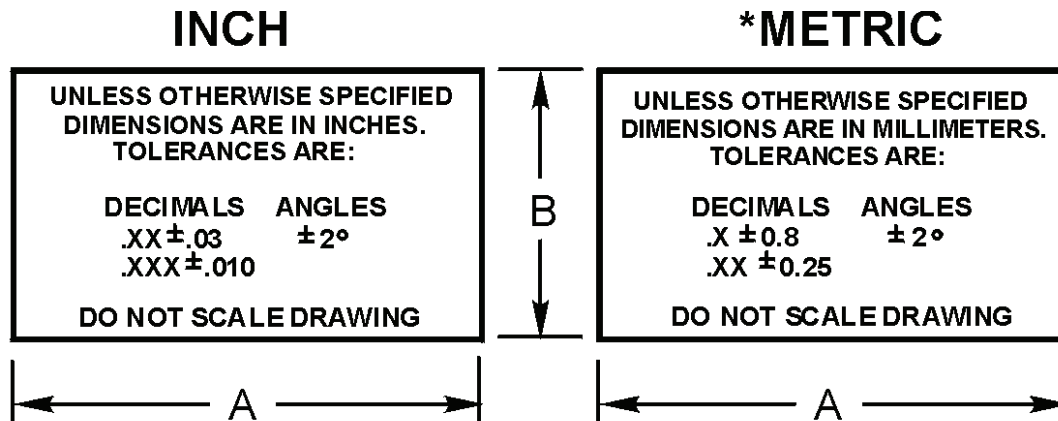

* See METRIC SECTION FIGURE M4-2 for an optional and more definitive METRIC Tolerance Block.

TOLERANCE BLOCK	A	B	DRAWING SIZES
INCH	1.50	.92	A, B, C and G
	2.50	1.00	D, E, F, H, J and K
METRIC	38	23	A4, A3, A2, A4 x 3 thru A4 x 9
	64	25	A1, A0, A1 x 3, A1 x 4, A0 x 2 and A0 x 3

DIMENSIONING AND TOLERANCING
BLOCK FORMAT.

FIGURE 6-20



6.10.17 Angle of Projection Block Format. The use of the Angle Projection Block as shown in FIGURE 6-21 is optional on "INCH" drawings but shall appear on "METRIC" drawings as near the Title Block as possible including the word "METRIC" in bold letters equivalent to the drawing number size. See METRIC format FIGURE 6-2M.

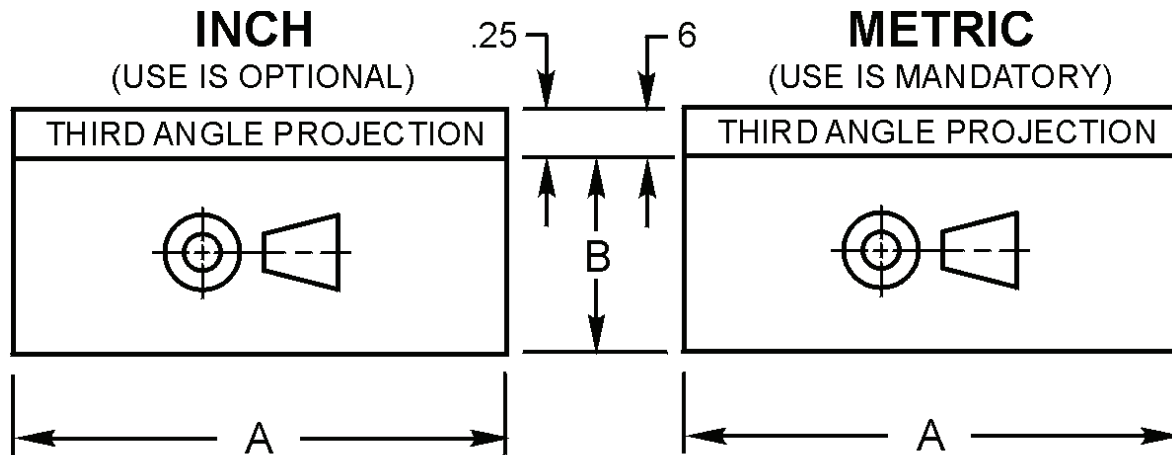

ANGLE OF PROJECTION	A	B	DRAWING SIZES
INCH	1.50	.75	A, B, C and G
	2.50	1.00	D, E, F, H, J and K
METRIC	38	19	A4, A3, A2 and A4 x 3 thru A4 x 9
	64	25	A1, A0, A1 x 3, A1 x 4, A0 x 2 and A0 x 3

ANGLE OF PROJECTION BLOCK FORMAT.
FIGURE 6-21

6.10.18 Microfilm Alignment Arrowheads. Microfilm arrowheads are placed in the margins of drawings to facilitate the alignment of microfilming. Their location is midway between the microfilm segment lines. See FIGURES 6-5 and 6-6 [METRIC 6-5M and 6-6M] for roll sizes and midway on all four (4) borders for flat sheet sizes. See FIGURES 6-1 and 6-1M for location and sizes.

6.10.19 Computer-Generated Drawing File Identifiers. The file number identifiers which locate the drawings digitized file that are used to generate drawings may be identified on the drawing as near the Title Block as possible.



6.11 BOOK-FORM DRAWINGS.

6.11.1 Book-Form Drawing Format. Book-form Drawing formats are normally preprinted in sizes listed in TABLE 6-2. INCH Sizes "A", "B" and "G" [METRIC "A4", "A3" and "A4 x 4"] may be intermingled respectively for a single drawing number for insertion in notebooks or suitable for binding.

INCH

SIZE	DIMENSION	
	VERTICAL	HORIZONTAL
A	11	8.5
B	11	17
*G	11	34

METRIC

SIZE	DIMENSION	
	VERTICAL	HORIZONTAL
A4	297	210
A3	297	420
*A4 x 4	297	841

*Limited to three (3) foldouts

BOOK- FORM DRAWING FORMAT SIZES.

TABLE 6-2

6.11.1.1 Sheet 1 Format. The standard INCH "A" or "B" [METRIC "A4" or "A3"] size format is used except for the Parts List, which is replaced with the "REV STATUS OF SHEETS" block extending from border to border. See FIGURE 6-22 and 6-24 [METRIC 6-22 and 6-24M].

6.11.1.2 Continuation Sheet Format. The continuation sheet format is made to the requirements of PARAGRAPH 6-9.2.1 except the revision block is omitted. See FIGURE 6-25 [METRIC 6-25M].

6.11.2 Preparing Book-Form Drawings. Book-form drawings are prepared on INCH "A", "B" or "G" [METRIC "A4", "A3", or "A4 x 4"] size format. Each principal section is prepared on one or more sheets. They are normally arranged in the following order, as applicable:

- a. Title Sheet
- b. Parts List
- c. General Notes
- d. Illustrations
- e. Tabulations



6.11.2.1 Drawing Identification And Title Block Entries. Book-form drawings are prepared to the requirements of PARAGRAPHS 6.9.2.2 and 6.9.2.3 and including the requirements of PARAGRAPH 6.11.2.2.

6.11.2.2 Revision Status Of Sheets Block. When the "REV STATUS OF SHEETS" block is not part of the preprinted format, it is added above the title block and completed as stated in PARAGRAPH 6.9.2.13. When the block is preprinted, the first unused sheet number block shall be lined out with a diagonal line. See FIGURE 6-22. Additional blocks are added up to and including the last sheet number. See FIGURE 6-23.

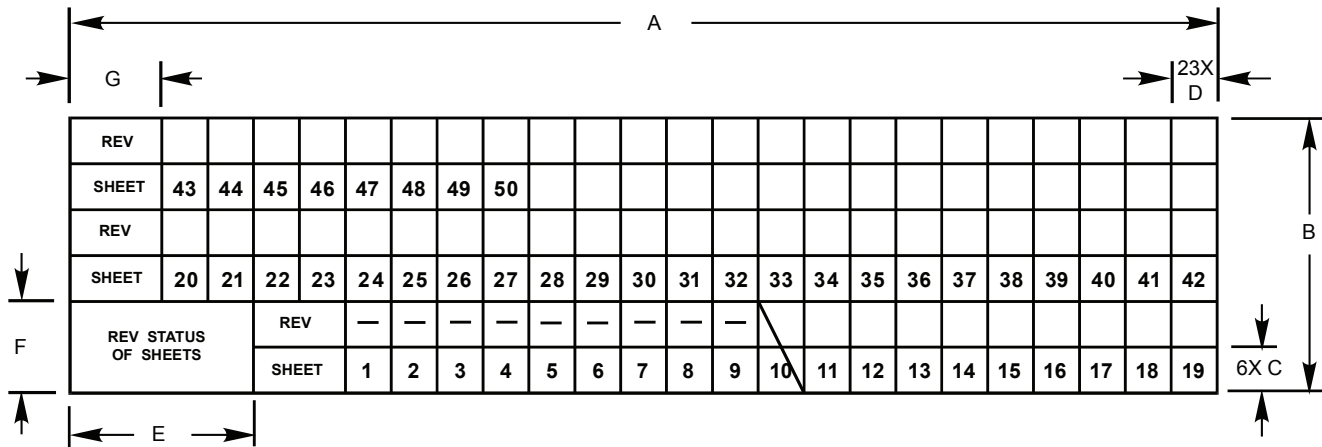

BOOK-FORM REVISION BLOCK	A	B	C	D	E	F	G
INCH	7.50	1.80	.30	.30	1.20	.60	.60
*METRIC	186	45	7.4	7.4	31	15	16

INCH AND METRIC DIMENSION VALUES SHOWN ABOVE ARE MINIMUM VALUES.

* METRIC DIMENSIONS ARE WHOLE MILLIMETERS NOT INCH TO MILLIMETER CONVERSIONS. DIMENSION 7.4 mm EXCEPTED.

INCH BOOK-FORM REVISION BLOCK: PREPRINTED.
METRIC BOOK-FORM REVISION BLOCK FORMAT: PREPRINTED.

FIGURE 6-22

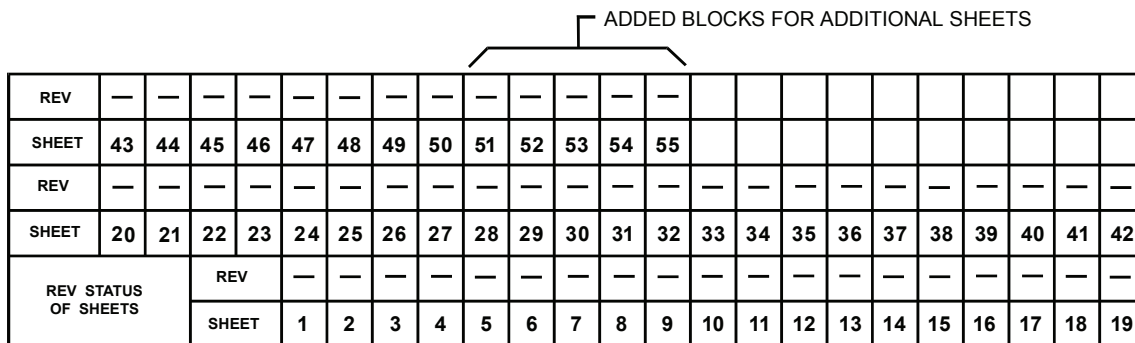

REVISIONS BLOCKS ADDED AS REQUIRED.

FIGURE 6-23

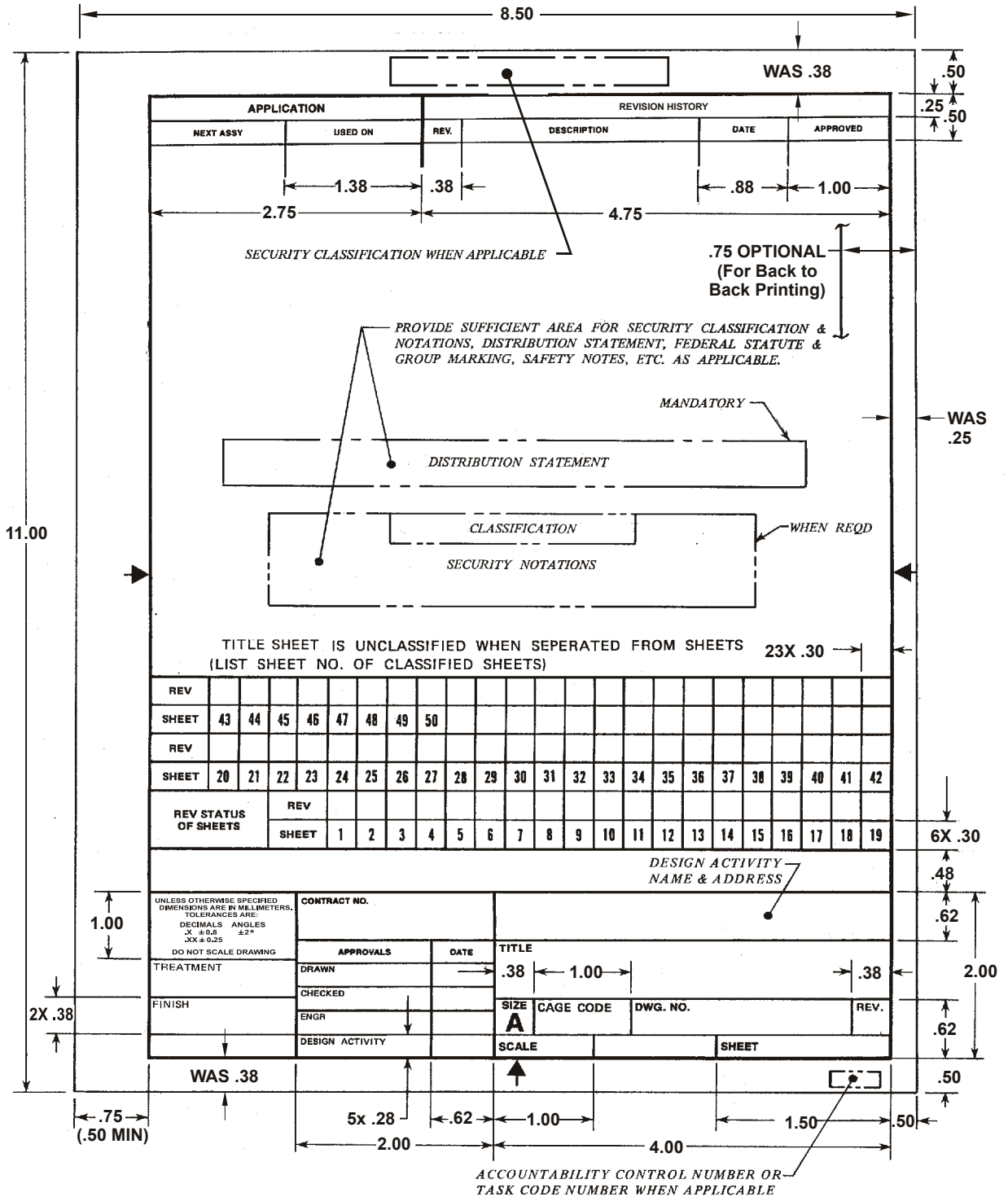

INCH, TITLE SHEET BOOK-FORM FORMAT.

FIGURE 6-24

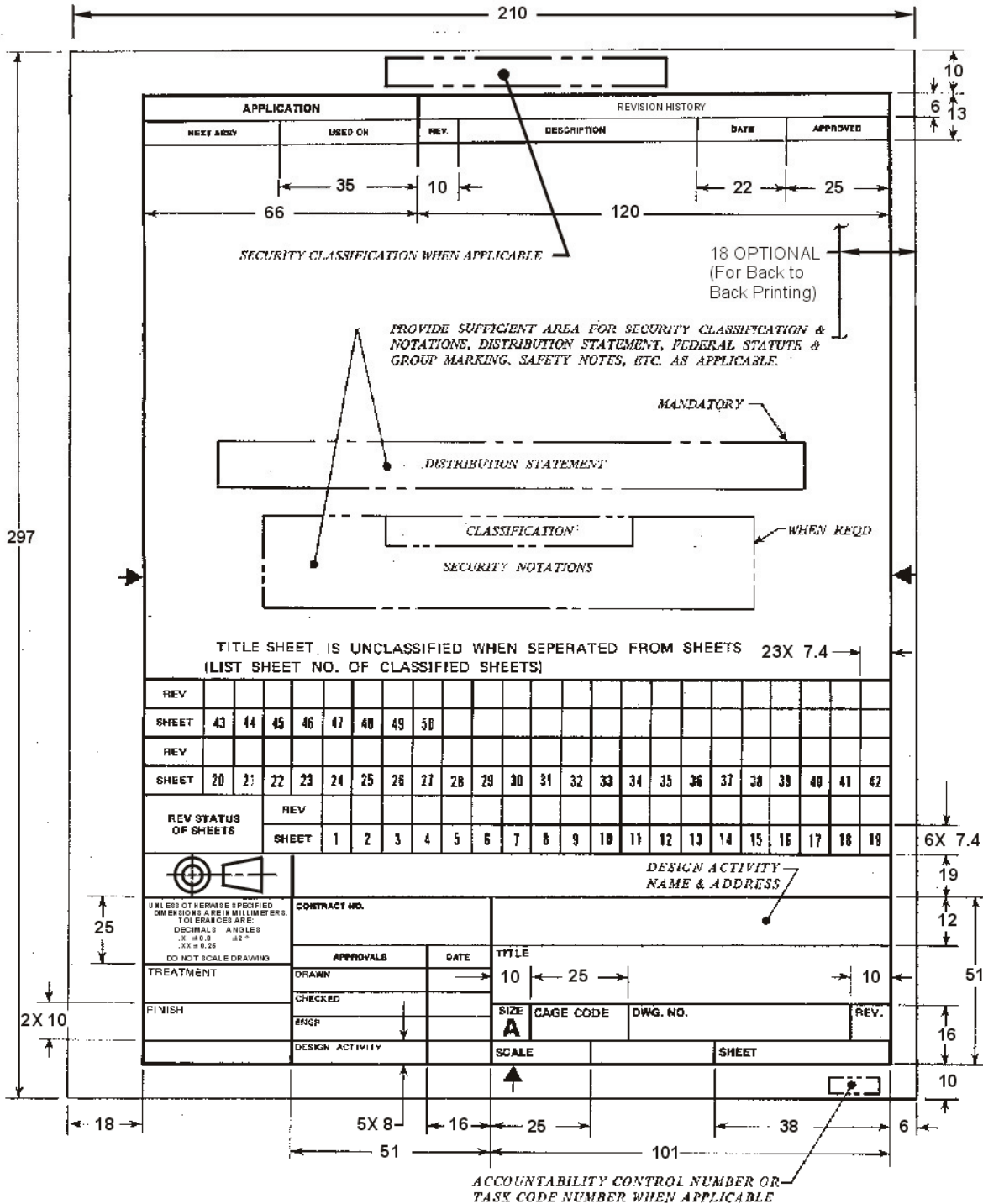

NOTE: METRIC DIMENSIONS ARE IN WHOLE MILLIMETERS AND ARE "NOT" INCH TO MILLIMETER CONVERSIONS.

METRIC, TITLE SHEET BOOK-FORMAT.
FIGURE 6-24M

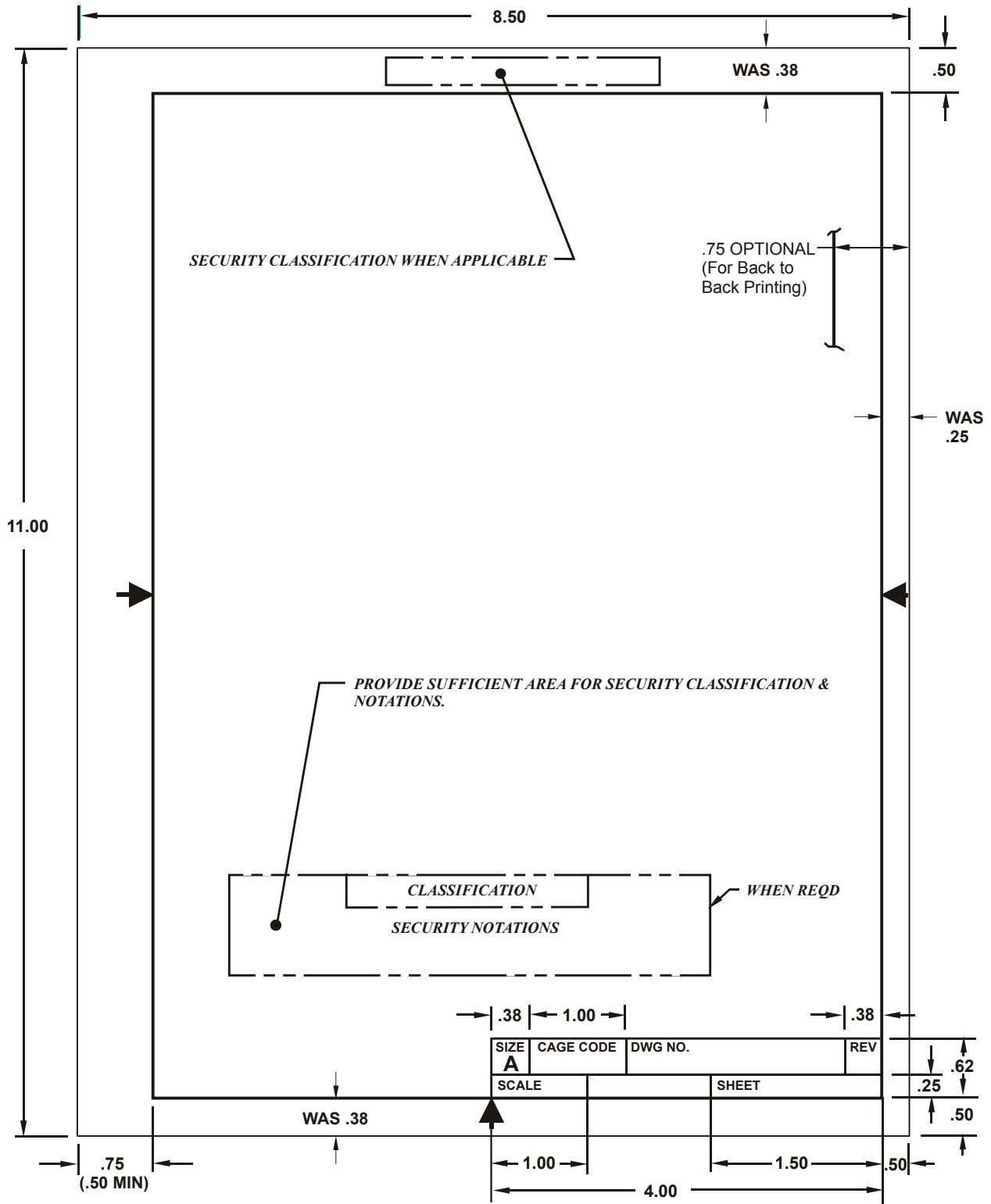

INCH, CONTINUATION SHEET BOOK-FORM FORMAT.

FIGURE 6-25

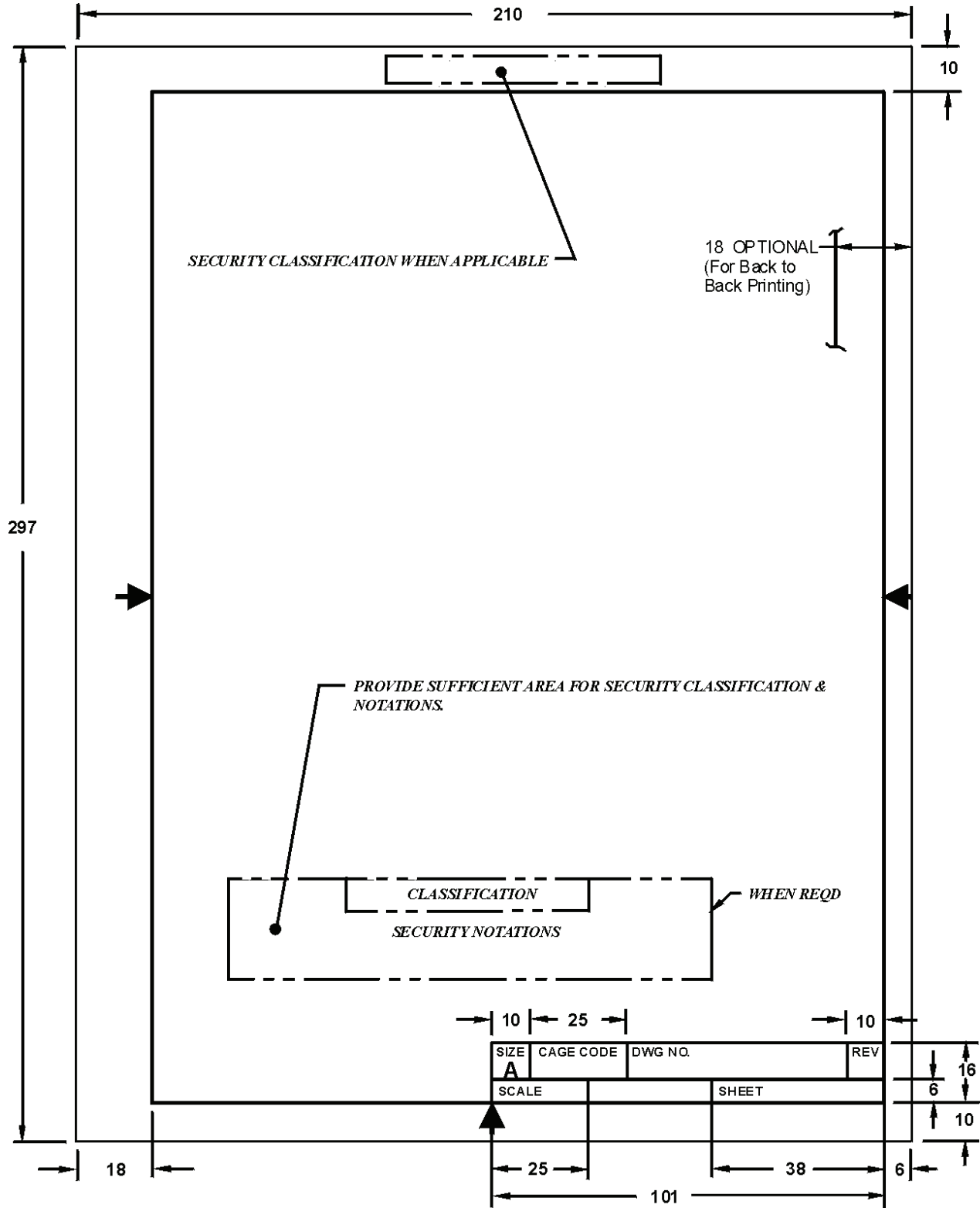

NOTE: METRIC DIMENSIONS ARE IN WHOLE MILLIMETERS AND ARE "NOT" INCH TO MILLIMETER CONVERSIONS.

METRIC, CONTINUATION SHEET BOOK-FORM FORMAT.

FIGURE 6-25M



6.12 PROPRIETARY NOTICES.

6.12.1 Application Of Proprietary Notice. Each drawing or sheet of a multisheet drawing is marked with a proprietary notice as soon as, or prior to, the time it discloses technical information. The notice is applied in the location(s) shown in FIGURE 6-2 or 6-3 for INCH "A" sizes, FIGURE 6-4 for INCH "B" through "F" [METRIC "A2" through "A0"] sizes and Figures 6-5 and 6-6 for roll sizes, or the legend should appear in each microfilm segment. Drawings in book-form need only delineate the legend on the title sheet. Unless otherwise directed by the Contract Administration or the Corporate Patent Department, a proprietary legend is used. It reads:

THE "BLANK" COMPANY, DETROIT, MICHIGAN, PART/DRAWING AE 203, DATED 1980-01-01 CORRESPONDS TO THE DATA DEPICTED ON THIS DRAWING IN PART OR IN WHOLE. THESE DATA ARE FURNISHED FOR UNRESTRICTED USE IN CONNECTION WITH ANY GOVERNMENT MANUFACTURE OR PROCUREMENT AND NO OTHER USE IS AUTHORIZED BY AFORESAID COMPANY.

6.12.2 Submittal Of Drawings To Customer/Government Ruling. When drawing originals or reproductions are submitted to the customer, the Contract Administration will issue instructions on whether the proprietary notice will remain unobscured, be removed, or be covered during reproduction. Normally, drawing originals or reproductions submitted to the Government will not bear proprietary notices.

6.13 SECURITY CLASSIFICATION MARKINGS. All markings, figures and examples that follow are for demonstration purposes only and do not infer that this section is classified.

6.13.1 Definitions. The definitions that follow have been taken from DOD 5220.22-M, "Industrial Security Manual for Safeguarding Classified Information" and may have been adjusted to limit the meaning to examples shown.

6.13.1.1 Access, Accessibility. The ability and opportunity to obtain knowledge of classified information. An individual, in fact, may have access to classified information by being in a place where such information is kept, if the security measures which are in force do not prevent him from gaining knowledge of the classified information.

6.13.1.2 Authorized Persons. Those persons who have a need to know for the classified information involved, and have been cleared for the receipt of such information. Responsibility for determining whether a person's duties require that he or she possess, or have access to, any classified information and whether he or she is authorized to receive it, rests upon the individual who has possession, knowledge, or control of the information involved, and not upon the prospective recipient.

6.13.1.3 Classified Information. Official information, including foreign classified information which has been determined to require, in the interests of national security, protection against unauthorized disclosure and which has been so designated. This includes the security levels of TOP SECRET, SECRET and CONFIDENTIAL information and/or material.

6.13.1.4 Compromise. The known or suspected exposure of classified information or material to an unauthorized person.



6.13.1.5 Confidential. The designation that shall be applied to information or material the unauthorized disclosure of which could be reasonably expected to cause damage to the national security that the original classification authority is able to identify or describe.

6.13.1.6 Document. Any recorded information regardless of its physical form or characteristics, exclusive of machinery, apparatus, equipment or other items of material.

6.13.1.7 Downgrade. A determination that classified information requires, in the interests of national security, a lower degree of protection against unauthorized disclosure than currently provided, together with a changing of the classification designation to reflect such lower degree of protection.

6.13.1.8 Formerly Restricted Data. Classified information jointly determined by the DOE and its predecessors and the DoD to be related primarily to the military utilization of atomic weapons and removed by the DOE from the Restricted Data category pursuant to section 142(d) of the Atomic Energy Act of 1954, as amended, and safeguarded as National Security Information, subject to the restrictions on transmission to other countries and regional defense organizations that apply to Restricted Data.

6.13.1.9 Information. Knowledge which can be communicated by any means.

6.13.1.10 Marking. Physically applying classification and associated stamps or marks to the classified document or material.

6.13.1.11 Need-To-Know. A determination made by the possessor of classified information that a prospective recipient, in the interest of national defense, has a requirement for access to (see PARAGRAPH 6.13.1.2), knowledge of, or possession of the classified information in order to perform tasks or services essential to the fulfillment of a classified contract or program approved by a User Agency.

6.13.1.12 Proprietary Information. Information concerning the products of a customer, associated prime contractor, vendor or a division of your company, which, if revealed without authorization, could adversely affect the owner's competitive position in business.

6.13.1.13 Restricted Data. All data (information) concerning 1.) design, manufacturer or utilization of atomic weapons; 2.) the production of special nuclear material; or 3.) the use of special nuclear material in the production of energy, but not to include data declassified or removed from the Restricted Data category pursuant to SECTION 142 of the Atomic Energy Act (see SECTION 11y, Atomic Energy Act of 1954, as amended, and formerly Restricted Data).

6.13.1.14 Secret. The designation that shall be applied only to information or material the unauthorized disclosure of which reasonably could be expected to cause serious damage to the national security that the original classification authority is able to identify or describe.

6.13.1.15 Security. Refers to safeguarding of information classified Top Secret, Secret or Confidential.



6.13.1.16 Technical Data. a.) Any unclassified information that can be used, or be adapted for use, in the design, production, manufacture, repair, overhaul, processing, engineering, development, operation, maintenance, or reconstruction of arms, ammunition and implements of war on the U.S. Munitions List, or b.) Any technology which advances the state-of-the-art or established a new art in an area of significant military applicability in the United States, or c.) classified information.

6.13.1.17 Top Secret. The designation that shall be applied only to information or material the unauthorized disclosure of which reasonably could be expected to cause exceptionally grave damage to the national security that the original classification authority is able to identify or describe.

6.13.1.18 Unauthorized Person. Any person not authorized to have access to specific classified information because of his lack of a "need-to-know" or proper level of personnel security clearance.

6.13.1.19 Upgrade. To determine that certain classified information require, in the interests of national security, a higher degree of protection against unauthorized disclosure than is currently provided, coupled with a changing of the classification designation to reflect the higher category.

6.13.1.20 Your Company Private. Unclassified information of a personal or private nature which can affect the welfare of your company or its employees.

6.13.1.21 Your Company Sensitive. Classified or unclassified information involving: trade secrets; unique engineering features; approaches to problems; process and concepts; unique manufacturing techniques of details relative to IR&D, state-of-the-art, planned or unplanned bidding programs, advanced marketing information, preproposal and proposal effort or other related information; all of which, if released to or obtained by competitors, would seriously impair your company's competitive position.

6.13.2 Types Of Markings. Classified drawings are protected and marked with the applicable security markings as soon as they divulge classified information. Classified drawings contain a minimum of six markings.

They are:

- a. Date of origin. See FIGURES 6-7 and 6-8.
- b. The design activity name and address, as part of the standard title block information. See FIGURES 6-7 and 6-8.
- c. Security classification. (See PARAGRAPH 6.13.3.)

Three additional permitted markings are:

- a. Federal statute. (See PARAGRAPH 6.13.4.)
- b. Group marking. (See PARAGRAPH 6.13.10.)
- c. The task code or accountability control number. (See PARAGRAPH 6.13.11.)

The markings are applied in the locations shown in FIGURES 6-2 and 6-3 for INCH "A" size, FIGURE 6-4 for INCH "B" through "F" [METRIC "A2" through "A0"] sizes and FIGURES 6-5 and 6-6 for roll sizes. The engineer is responsible for establishing the correct classification and group marking and for informing the drafter when they will be applied. Markings shall be applied by rubber stamp or applied as preprinted decals in black. Security markings shall be larger than any other markings or letter size on the drawing or associated list.



6.13.2.1 Authorized Security Markings. Security Classification Markings and Notes shall be in accordance with DoD 5220.22-M. Markings shall be equal to or larger than the largest lettering on the drawing or list.

6.13.2.2 Security Markings Location Priority. Security Marking notations, when required, shall be the first note closest to the Title Block ahead of all other required or optional notes, except for Drawing Type, e.g. SOURCE CONTROL DRAWING, ALTERED PART DRAWING, etc.

6.13.3 Security Classification. The three basic classifications are CONFIDENTIAL, SECRET and TOP SECRET. These may be supplemented with one of several prefixes (e.g. SEATO, CENTO, NATO, etc.) or suffixes (e.g. MODIFIED HANDLING AUTHORIZED, RESTRICTED DATA, etc.).

6.13.3.1 Security Classifications On Flat Size Drawings. On flat size INCH drawings "A", "B", "C", "D", "E", and "F" [METRIC "A4", "A3", "A2", "A1" and "A0"] security markings are located as shown in FIGURES 6-2, 6-3 and 6-4.

6.13.3.2 Security Classifications On Roll Size Drawings. Roll size drawings are marked as shown in FIGURES 6-5 and 6-6. The highest security classification applicable to the entire sheet is repeated in all locations so that it will reproduce on each microfilm frame.

6.13.3.3 Drawing Title Limitation. So far as it is possible as stated in SECTION 8 drawing titles can not contain classified information. However, they will still be marked with "(U)" for unclassified. Each classified drawing shall indicate parenthetically, after the last word of the title, the title classification, abbreviated as follows:

- (U) - Unclassified
- (C) - Confidential
- (S) - Secret
- (TS) - Top Secret
- (RD) - Restricted Data
- (FRD) - Formerly Restricted Data

EXAMPLE: GAS CYLINDER, COMPRESSED (U)

6.13.3.4 Location of Security Markings on Associated Lists. Security classification shall be centered outside the border at the top and bottom of the list. Security notes shall be placed as shown on Figures 6-26 and 6-27.



CLASSIFICATION																
PARTS LIST		1. DESIGN ACTIVITY				1a. CONTRACT NO.	2. CAGE CODE CURRENT ORIGINAL		3. ORG DATE YR-MO-DA		4. PL		5. REV			
6. LIST TITLE				7. END ITEM				8. APPROVAL			9. REV AUTH NO.			10. SHEET OF SHEETS		
11. ITEM OR FIND NUMBER	12. QTY REQD	13. UNIT OF MEASURE	14. CAGE CODE	15. PART OR IDENTIFYING NUMBER		16. DRAWING/DOCUMENR 16a. SIZE NUMBER		17. REV LTR	18. SHT NO.	19. NOMENCLATURE OR DESCRIPTION			20. WT UNIT OR ASSY	21. HCI or HCP	22. SUPL LIST	23. NOTES
DISTRIBUTION STATEMENT																
SECURITY NOTATIONS																
24. LTR	25. DESCRIPTION/AUTH		26. DATE YR-MO-DA	27. APVD	24. LTR	25. DESCRIPTION/AUTH		26. DATE YR-MO-DA	27. APVD							
										28. SUE NO	29. NEXT ASSEMBLY		30. USED ON			
CLASSIFICATION																

LOCATION OF SECURITY MARKINGS ON ASSOCIATED LISTS.

FIGURE 6-26



CLASSIFICATION

PARTS LIST	PL-11743133	FRANKFORD ARSENAL	CONTRACT NO.	REV. DATE 12 NOV 75
DOCUMENT // PART NUMBER	F 11743133	PHILADELPHIA, PA		REVISION LETTER B
WIRING HARNESS, BRANCHED			CAGE CODE 19200	SHEET 1
CHANGE CONTROL NUMBER	F595418	AUTHENTICATION		ORIG. DATE 740131

FND QTY UNIT	CAGE	PART OR	DRAWING / DOCUMENT	NOMENCLATURE OR DOCUMENT TITLE	SUP
NO. REQ MEAS	CODE	IDENTIFYING NO.	SIZE NUMBER		LIST
1	11738017-2	B	11738017	CONNECTOR, RECEPTACLE, ELECTRICAL	
1	11738913	B	11738913	CONNECTOR, ELECTRICAL	
1	11738920	B	11738920	CONTACT, PLUG RECEPTACLE	
1	11741514	B	11741514	CONNECTOR, RECEPTACLE ELECTRICAL -25 PIN	
	REFERENCE DWG,	F	11743132	ELECTRONICS UNIT, SCHEMATIC DIAGRAM	
1	11743316	F	11743316	BOARD ASSY - INTERCONNECTING	X
1	11743330-1	C	11743330	STRAP, CABLE IDENTIFICATION	
1	11743331	D	11743331	TERMINAL BOARD ASSY	X
1	11743698-1	C	11743698	CONNECTOR, RECEPTACLE, ELECTRICAL, HERMETIC	
1	11743698-2	C	11743698	CONNECTOR, RECEPTACLE, ELECTRICAL, HERMETIC	
1	11743698-3	C	11743698	CONNECTOR, RECEPTACLE, ELECTRICAL, HERMETIC	
AR	11745399	A	11745399	WIRE HARDNESS, FABRICATION & ROUTING, PROCESS FOR	
AR	11745401	A	11745401	TERMINATING SHIELDING WIRES, PROCESS FOR	
AR	11745403	A	11745403	CABLE & HARDNESS CONNECTORS, ASSY, PROCEDURE FOR	
AR	11745477	A	11745477	IDENT OF ELEC WIRE, CA SLVG, AND PTS BY PRINTING PRCS	
AR	MIL-W-16878-CSD	MIL-W-16878		JACKET, FLUOROCARBON COLOR OPTIONAL	
AR	MIL-W 16878-CW	MIL-W-16878		JACKET, FLUOROCARBON COLOR WHITE	
AR	MIL-W-16878-S30	MIL-W-16878		BRAID, SHIELD, SIZE 30, SILVER PLATED COPPER	
AR	MIL-W-16878-S36	MIL-W-16878		BRAID, SHIELD, SIZE 36, SILVER PLATED COPPER	
AR	MMM-A-134	MMM-A-134		ADHESIVE, EPOXY RESIN, METAL STRUCTURAL BONDING	
1	M83723-12H1832N	MIL-C-83723/12		CONNECTOR, ELECT, RECEPTACLE, SINGLE HOLE MOUNT, CLASS H	
AR	RG316/U	MIL-C-17/113		CABLE, RADIO FREQUENCY, COAXIAL	
AR	TE-20-19S-C-S	MIL-W-16878/4		WIRE, TEFLON INSULATED, TYPE E-20, 19 STRANDS, COLOR BLACK	
AR	TE-20-19S-C-W	MIL-W-16878/4		WIRE, TEFLON INSULATED, TYPE E-20, 19 STRANDS, COLOR WHITE	
AR	TE-22-19S-C-8R	MIL-W-16878/4		WIRE, TEFLON INSULATED, TYPE E-22, 19 STRANDS, COLOR BROWN	
AR	16878/4E22-198	MIL-W-16878/4		WIRE, INSUL, 22 AWG, 19 STRANDS, COLOR BLACK	
AR	16878/4E22-195	MIL-W-16878/4		WIRE, TEFLON, INSULATED, TWISTED PR TYPE E22, 19 STRANDS	
AR	16878/4E22-19W	MIL-W-16878/4		WIRE, INSULATED, 22 AWG, 19 STRANDS, COLOR WHITE	

DISTRIBUTION STATEMENT

SECURITY NOTATIONS

CLASSIFICATION

LOCATION OF SECURITY MARKING ON COMPUTER GENERATED ASSOCIATED LISTS.

FIGURE 6-27



6.13.3.5 Location of Security Markings of Drawings in Book-Form. Security markings shall be placed on pages containing classified information. Security notes shall be placed above the title block. Security classification shall be placed at top of pages. Place the following note on the cover sheet. "COVER SHEET IS UNCLASSIFIED WHEN SEPARATED FROM SHEETS (List all Classified Sheet Number)". See FIGURE 6-24. For continuation sheets see FIGURE 6-25.

6.13.3.6 Security Marking Notations. A cross section of sample special security notes shown in FIGURE 6-28 are in accordance with DoD 5220.22-M.

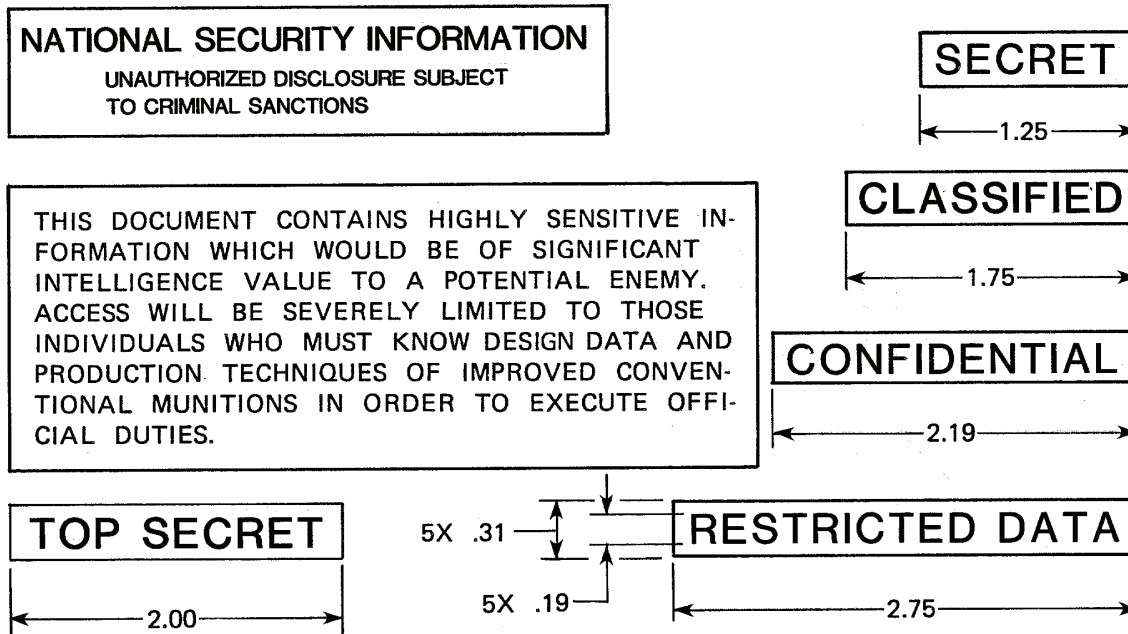

SAMPLE SECURITY MARKING NOTATIONS AND CLASSIFICATIONS.

FIGURE 6-28



6.13.4 Federal Statute. All classified drawings, ("C", "S", "TS", and "FRD") except those marked "RESTRICTED DATA", will be marked with the espionage clause. e.g.

CONFIDENTIAL

THIS MATERIAL CONTAINS INFORMATION AFFECTING THE NATIONAL DEFENSE OF THE UNITED STATES WITHIN THE MEANING OF ESPIONAGE LAWS. TITLE 18, U.S.C., SECTIONS 793 AND 794, THE TRANSMISSION OR REVELATION OF WHICH IN ANY MANNER TO AN UNAUTHORIZED PERSON IS PROHIBITED BY LAW.

6.13.5 All Drawings Marked "RESTRICTED DATA". Drawings will be marked with the Atomic Energy Commission restriction. e.g.

RESTRICTED DATA

THIS MATERIAL CONTAINS "RESTRICTED DATA" AS DEFINED IN THE ATOMIC ENERGY ACT OF 1954. UNAUTHORIZED DISCLOSURE SUBJECT TO ADMINISTRATIVE AND CRIMINAL SANCTIONS. CLASSIFIED BY _____

6.13.6 Formerly Restricted Data Notation. Drawing designated as FORMERLY RESTRICTED DATA shall be marked with the following notation above the title block, and at the top and bottom of the drawing, and protective flaps if applicable, e.g.

FORMERLY RESTRICTED DATA
UNAUTHORIZED DISCLOSURE SUBJECT TO ADMINISTRATIVE AND CRIMINAL SANCTIONS.
HANDLE AS "RESTRICTED DATA" IN FOREIGN DISSEMINATION. SECTION 144b, ATOMIC ENERGY ACT 1954.
CLASSIFIED BY _____



6.13.7 Marking for Derivatively Classified Documents. All classified information shall be marked to reflect the sources of the classification and declassification instructions in a prominent position such as on the cover, first page or title page.

DERIVED FROM _____ DECLASSIFY ON _____

- a. The “DERIVED FROM” line is to link the derivative classification applied to the material by the contractor and the source document(s) or classifications guide(s) under which it was classified.
- b. The “DECLASSIFY ON” line is to provide declassification instructions appropriate for the material. The contractor shall use the information specified in the contract Security Classification Specification.
- c. Material containing RESTRICTED DATA (RD) or FORMERLY RESTRICTED DATA (FRD) shall not have a “DECLASSIFY ON” line.

6.13.8 Add On “DOWNGRADE TO” to Derivatively Classified Documents. When downgrading instructions are contained in the contract Security Classification Specification, classification guide or source document, a “DOWNGRADE TO” line will be included. When completing this line, the contractor shall insert SECRET or CONFIDENTIAL and effective date or event. The markings used to show this information are as follows:

DERIVED FROM _____ DOWNGRADE TO _____ ON _____ DECLASSIFY ON _____
--

6.13.9 “CLASSIFIED BY” Line and “REASON CLASSIFIED” Line. As a general rule, a “CLASSIFIED BY” line and a “REASON CLASSIFIED” line will only be shown on originally classified documents. However, certain agencies may require that derivatively classified documents contain a “CLASSIFIED BY” line to identify the derivative classifier and a “REASON CLASSIFIED” line to identify the specific reason for the derivative classification. Instructions for the use of these lines as applicable in the security classification guidance provided with the contract.

CLASSIFIED BY _____ DECLASSIFIED ON _____ REVIEW ON _____ EXTENDED BY _____ REASON _____ DOWNGRADED TO _____



6.13.10 Regrading Classification Of Drawings. Regraded drawings shall be marked or stamped (not typed) with the appropriate classification and the old markings shall be lined through. The new marking shall be accompanied by the regrading authority. Regrading shall be accomplished through coordination with the Security Office. Reclassification action constitutes a change. An applicable entree in the revision block and sample FIGURE appear in SECTION 23.

6.13.11 Security Markings On Multisheet Drawings. All sheets of a classified multisheet drawing are marked with the same security classification. Furthermore, all sheets carry the same security markings as sheet 1 except the task code or accountability control number is omitted from the continuation sheets. Any deviation from this procedure must be approved by the program or facility security representative and shall be handled as follows:

6.13.11.1 Highest Classification Assignment. The highest classification assigned to any sheet within the entire drawing shall be shown on the first sheet.

6.13.11.2 Multiple Classification Assignment. If the classification of the first sheet is lower than the classification for any of the remaining sheets, the first sheet must show the highest classification marking as well as its own. This shall be done in the manner of the following examples:

SECRET
(THIS SHEET IS CONFIDENTIAL)

CONFIDENTIAL
(THIS SHEET IS UNCLASSIFIED)

6.13.11.3 Continuation Sheet Markings. Each continuation sheet of a multisheet drawing need not show the overall or highest classification of the drawing. It is only necessary that each such sheet bear its own appropriate security marking.



6.13.12 Group Markings. Classified drawings are marked with one of four group markings, e.g.

GROUP 1

**EXCLUDED FROM AUTOMATIC DOWNGRADING
AND DECLASSIFICATION**

GROUP 2

EXEMPTED FROM AUTOMATIC DOWNGRADING

GROUP 3

**DOWNGRADED AT 12 YEAR INTERVALS;
NOT AUTOMATICALLY DECLASSIFIED**

GROUP 4

**DOWNGRADED AT 3 YEAR INTERVALS
DECLASSIFIED AFTER 12 YEARS**

Group 3 and 4 may be modified by Government authority to read:

GROUP 3

**DOWNGRADE TO:
SECRET ON (Effective Date)
CONFIDENTIAL ON (Effective Date)
NOT AUTOMATICALLY DECLASSIFIED**

GROUP 4

**DOWNGRADE TO:
SECRET ON (Effective Date)
CONFIDENTIAL ON (Effective Date)
DECLASSIFY ON (Effective Date)**

6.13.13 Task Code Or Accountability Control Number. The task code number will be marked on all confidential drawings. The accountability control number will be marked on all secret or top secret drawings. See FIGURES 6-2, 6-3, 6-4, 6-5 and 6-6 for locations.

6.13.14 Radioactive Materials. All drawings pertaining to items using radioactive materials shall be suitably marked with a caution symbol and note as applicable in accordance with ANSI N2.1 and ANSI N12.1.



6.14 DISTRIBUTION STATEMENT MARKINGS ON TECHNICAL DRAWINGS AND ASSOCIATED LISTS.

6.14.1 Responsibility for Selecting Marking Document Statements. Documents prepared for DoD shall have the appropriate Distribution Statement applied to the document as provided by the controlling DoD office responsible for the generation of the document.

6.14.2 Applicability of Distribution Statement.

6.14.2.1 Applicability. Distribution statements shall be included on all drawings and associated lists associated with procurements involving components of the DoD.

6.14.2.2 Location. Distribution statements shall be included on all single sheet drawings and associated lists and sheet 1 (one) of such multi-sheet documents.

6.14.2.3 Method of Application. Statements and notices shall be applied by decals, rubber stamp or by lettering template. Lettering shall meet the reproduction requirements of the engineering drawing/associated lists and color black.

6.14.2.4 Size of Lettering. Lettering shall be equal to the largest size lettering on the drawing or associated list.

6.14.3 Distribution Statements. There are seven different distribution statements provided in DoD D 5230.24 that may be used to control dissemination of DoD technical documents, ranging from complete public release to only specific release on a case by case basis by the controlling DoD office. Certain types of technical documents preclude placing the entire notice. To accommodate this problem, each distribution statement contains an authorized abbreviated form.

a.

DISTRIBUTION STATEMENT A. APPROVED FOR PUBLIC RELEASE; DISTRIBUTION IS UNLIMITED.

(1) ABBREVIATED FORM IS: "**STATEMENT A, UNLIMITED.**"

b.

**DISTRIBUTION STATEMENT B. DISTRIBUTION AUTHORIZED TO U.S. GOVERNMENT AGENCIES ONLY
FILL IN REASON AND DATE OF DETERMINATION; YR-MO-DA. OTHER REQUESTS FOR THIS
DOCUMENT SHALL BE REFERRED TO INSERT NAME OF CONTROLLING DoD OFFICE.**

(1) ABBREVIATED FORM IS: "**STATEMENT B, US GOV'T (CONTROLLING DoD OFFICE)**"

NOTE: SEE PARAGRAPH 6.14.5 FOR ACCOMPANYING NOTE.



c.

DISTRIBUTION STATEMENT C. DISTRIBUTION AUTHORIZED TO U.S. GOVERNMENT AGENCIES AND THEIR CONTRACTORS *FILL IN REASON AND DATE OF DETERMINATION; YR-MO-DA. OTHER REQUESTS FOR THIS DOCUMENT SHALL BE REFERRED TO INSERT NAME OF CONTROLLING DoD OFFICE.*

- (1) ABBREVIATED FORM IS: "**STATEMENT C, GOV'T & CONTRACTORS**, (*CONTROLLING DoD OFFICE*)
NOTE: SEE PARAGRAPH 6.14.5 FOR ACCOMPANYING NOTE.

d.

DISTRIBUTION STATEMENT D. DISTRIBUTION AUTHORIZED TO THE DEPARTMENT OF DEFENSE AND DoD CONTRACTORS ONLY. *FILL IN REASON AND DATE OF DETERMINATION; YR-MO-DA. OTHER REQUESTS SHALL BE REFERRED TO INSERT NAME OF CONTROLLING DoD OFFICE.*

- (1) ABBREVIATED FORM IS: "**STATEMENT D, DoD & CONTRACTORS**, (*CONTROLLING DoD OFFICE*)"
NOTE: SEE PARAGRAPH 6.14.5 FOR ACCOMPANYING NOTE.

e.

DISTRIBUTION STATEMENT E. DISTRIBUTION AUTHORIZED TO DoD COMPONENTS ONLY *FILL IN REASON AND DATE OF DETERMINATION; YR-MO-DA. OTHER REQUESTS FOR THIS DOCUMENT SHALL BE REFERRED TO INSERT NAME OF CONTROLLING DoD OFFICE.*

- (1) ABBREVIATED FORM IS: "**STATEMENT E, DoD ONLY**, (*CONTROLLING DoD OFFICE*)"
NOTE: SEE PARAGRAPH 6.14.4 AND 6.14.5 FOR ACCOMPANYING NOTE.

f.

DISTRIBUTION STATEMENT F. FURTHER DISTRIBUTION ONLY AS DIRECTED BY *INSERT NAME OF CONTROLLING OFFICE; OR HIGHER AUTHORITY. FILL IN REASON AND DATE OF DETERMINATION; YR-MO-DA.*

- (1) ABBREVIATED FORM IS: "**STATEMENT F, REQUEST APPROVAL OF** (*CONTROLLING DoD OFFICE*)"
NOTE: SEE PARAGRAPH 6.14.5 FOR ACCOMPANYING NOTE.



g.

DISTRIBUTION STATEMENT X. DISTRIBUTION AUTHORIZED TO U.S. GOVERNMENT AGENCIES AND PRIVATE INDIVIDUALS OR INTERPRISES ELIGIBLE TO OBTAIN EXPORT-CONTROLLED TECHNICAL DATA IN ACCORDANCE WITH CONTROLLING DoD OFFICE DoD 5230.25 OR IMPLEMENTING SERVICE REGULATIONS; DATE OF DETERMINATION; YR-MO-DA.

(1) ABBREVIATED FORM IS: "**STATEMENT X, CERTIFIED CONTRACTORS,(CONTROLLING DoD OFFICE)**".

NOTE: SEE PARAGRAPH 6.14.5 FOR ACCOMPANYING NOTE.

6.14.4 Export Limitations. Distribution Statement E shall also be accompanied by the following associated notice.

WARNING -THIS DOCUMENT CONTAINS TECHNICAL DATA WHOSE EXPORT IS RESTRICTED BY THE ARMS EXPORT CONTROL ACT (TITLE 22, U.S.C. SEC 2751 ET SEQ.) OR THE EXPORT ADMINISTRATION ACT OF 1979, AS AMENDED, TITLE 50, U.S.C., APP 2401 ET SEQ. VIOLATIONS OF THESE EXPORT LAWS ARE SUBJECT TO SEVERE CRIMINAL PENALTIES.

(1) ABBREVIATED FORM IS: "**WARNING: EXPORT CONTROLLED**"

6.14.5 Classified Documents. Distribution Statements B,C, D, E, F, and X shall also be accompanied by the following notice:

DESTRUCTION NOTICE- FOR CLASSIFIED DOCUMENTS, FOLLOW THE PROCEDURES IN DoD 5220.22-M, INDUSTRIAL SECURITY MANUAL, CHAPTER 5, SECTION PARAGRAPHS 700 THROUGH 711 OR DoD 5200.1-R, INFORMATION SECURITY PROGRAM REGULATION, CHAPTER IX. FOR UNCLASSIFIED, LIMITED DOCUMENTS, DESTROY BY ANY METHOD THAT WILL PREVENT DISCLOSURE OF CONTENTS OR RECONSTRUCTION OF THE DOCUMENT.

6.14.6 Location Of Associated Notices. Notices required in association with Distribution Statement See PARAGRAPHS 6.14.4 and 6.14.5 shall be located in the same general area as the Distribution Statement.

6.14.7 Location On Drawing And Associated Lists. Distribution Statements shall be located on drawings and lists in accordance with FIGURES 6-24 thru 6-32.2.

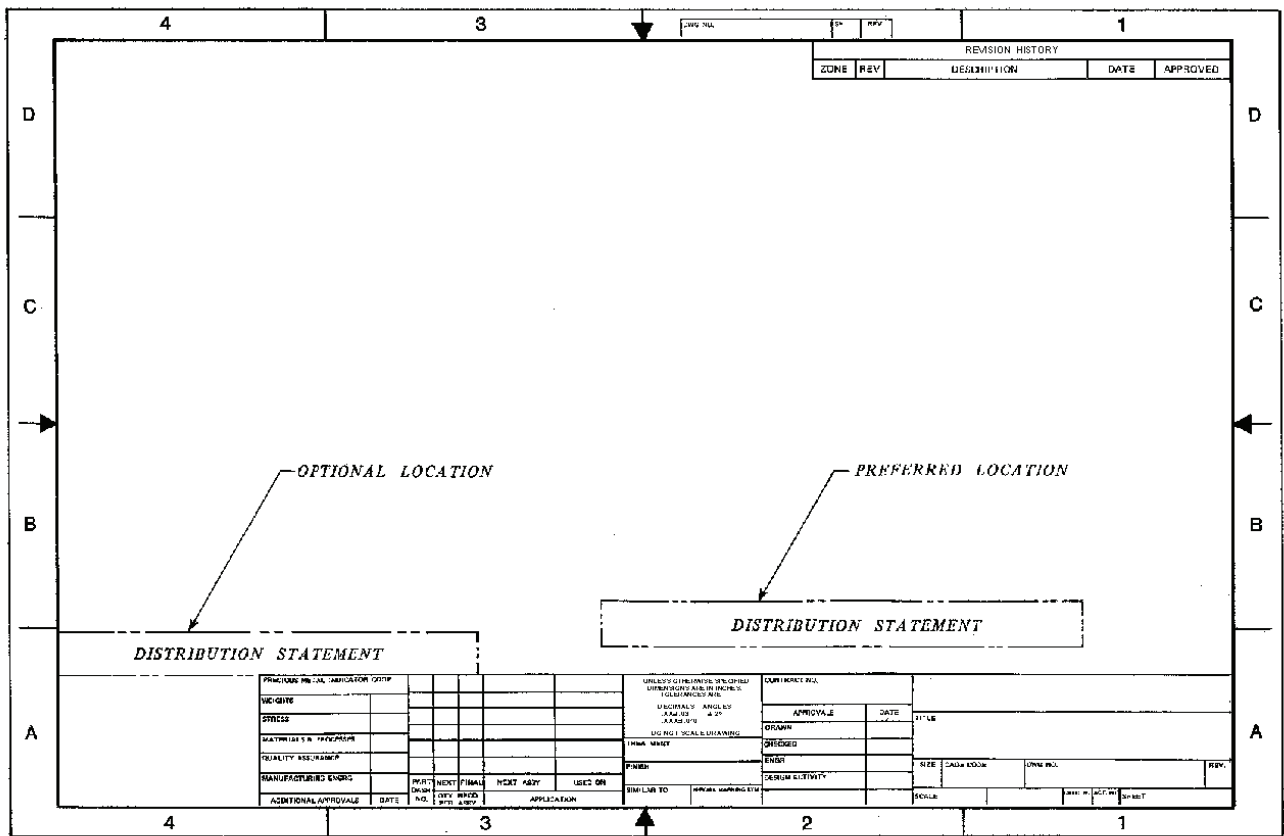

DISTRIBUTION STATEMENT LOCATION FOR "B" SIZE FORMAT.

FIGURE 6-29

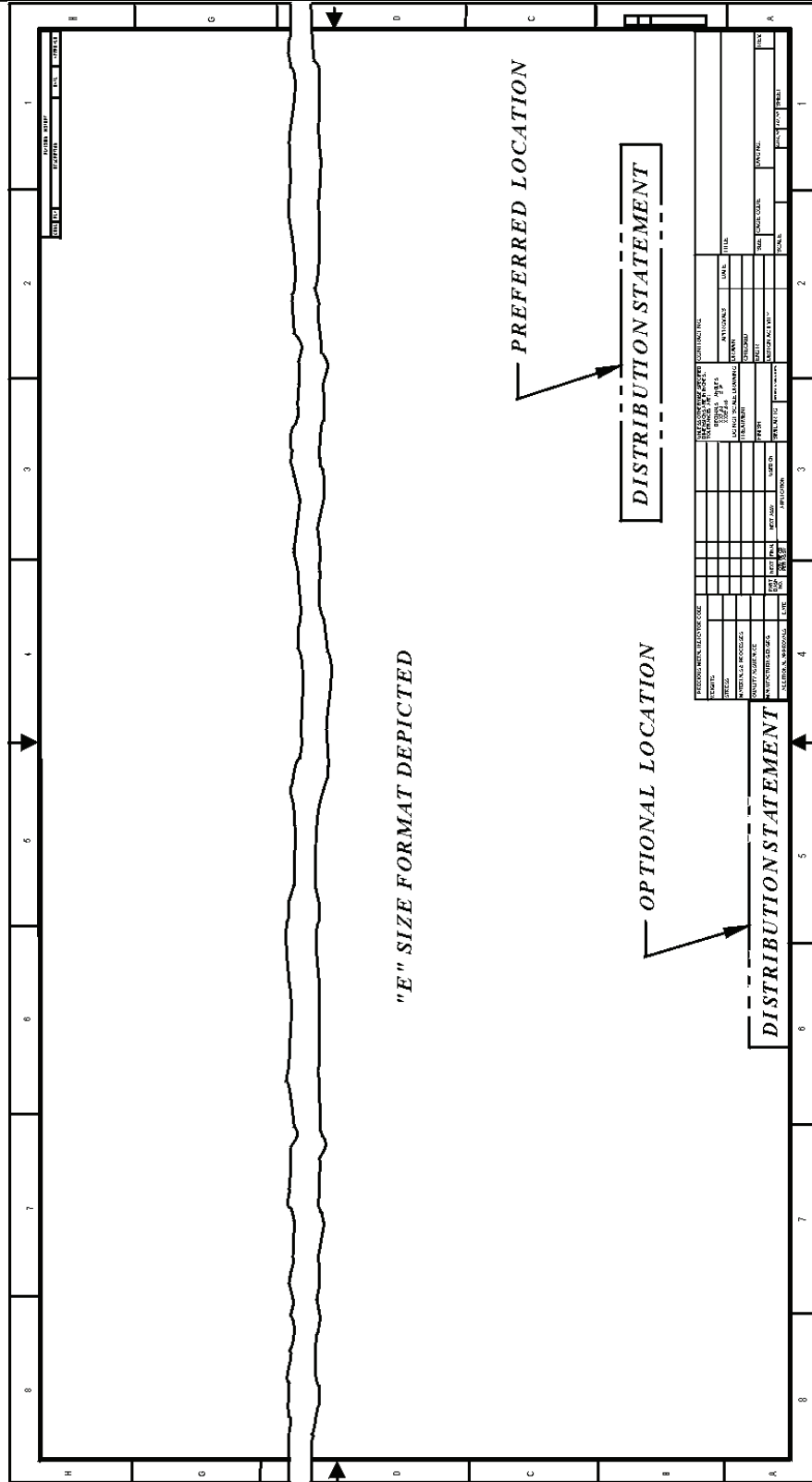

DISTRIBUTION STATEMENT LOCATION FOR INCH "C", "D", "E", "F", "H", "J", AND "K" FORMAT,
[METRIC "A2", "A1", "A0", "A1 x 3" AND "A0 x 2"] .

FIGURE 6-30



PARTS LIST		PL-11743133		FRANKFORD ARSENAL		CONTRACT NO.	REV. DATE 12 NOV 75	
DOCUMENT / /PART NUMBER		F 11743133		PHILADELPHIA, PA			REVISION LETTER B	
WIRING HARNESS, BRANCHED						CAGE CODE	19200	
CHANGE CONTROL NUMBER		F595418		AUTHENTICATION			SHEET 1	
							ORIG. DATE 740131	
FND	QTY	UNIT	CAGE	PART OR	DRAWING / DOCUMENT	NOMENCLATURE OR DOCUMENT TITLE		SUP
NO.	REQ	MEAS	CODE	IDENTIFYING NO.	SIZE NUMBER			LST
1				11738017-2	B 11738017	CONNECTOR, RECEPTACLE, ELECTRICAL		
1				11738913	B 11738913	CONNECTOR, ELECTRICAL		
1				11738920	B 11738920	CONTACT, PLUG RECEPTACLE		
1				11741514	B 11741514	CONNECTOR, RECEPTACLE ELECTRICAL -25 PIN		
				REFERENCE DWG,	F 11743132	ELECTRONICS UNIT, SCHEMATIC DIAGRAM		
1				11743316	F 11743316	BOARD ASSY - INTERCONNECTING		X
1				11743330-1	C 11743330	STRAP, CABLE IDENTIFICATION		
1				11743331	D 11743331	TERMINAL BOARD ASSY		X
1				11743698-1	C 11743698	CONNECTOR, RECEPTACLE, ELECTRICAL, HERMETIC		
1				11743698-2	C 11743698	CONNECTOR, RECEPTACLE, ELECTRICAL, HERMETIC		
1				11743698-3	C 11743698	CONNECTOR, RECEPTACLE, ELECTRICAL, HERMETIC		
AR				11745399	A 11745399	WIRE HARDNESS, FABRICATION & ROUTING, PROCESS FOR		
AR				11745401	A 11745401	TERMINATING SHIELDING WIRES, PROCESS FOR		
AR				11745403	A 11745403	CABLE & HARDNESS CONNECTORS, ASSY, PROCEDURE FOR		
AR				11745477	A 11745477	IDENT OF ELEC WIRE, CA SLVG, AND PTS BY PRINTING PRCS		
AR				MIL-W-16878-CSD	MIL-W-16878	JACKET, FLUOROCARBON COLOR OPTIONAL		
AR				MIL-W-16878-CW	MIL-W-16878	JACKET, FLUOROCARBON COLOR WHITE		
AR				MIL-W-16878-S30	MIL-W-16878	BRAID, SHIELD, SIZE 30, SILVER PLATED COPPER		
AR				MIL-W-16878-S36	MIL-W-16878	BRAID, SHIELD, SIZE 36, SILVER PLATED COPPER		
AR				MMM-A-134	MMM-A-134	ADHESIVE, EPOXY RESIN, METAL STRUCTURAL BONDING		
1				M83723-12H1832N	MIL-C-83723/12	CONNECTOR, ELECT, RECEPTACLE, SINGLE HOLE MOUNT, CLASS H		
AR				RG316/U	MIL-C-17/113	CABLE, RADIO FREQUENCY, COAXIAL		
AR				TE-20-19S-C-S	MIL-W-16878/4	WIRE, TEFLON INSULATED, TYPE E-20, 19 STRANDS, COLOR BLACK		
AR				TE-20-19S-C-W	MIL-W-16878/4	WIRE, TEFLON INSULATED, TYPE E-20, 19 STRANDS, COLOR WHITE		
AR				TE-22-19S-C-8R	MIL-W-16878/4	WIRE, TEFLON INSULATED, TYPE E-22, 19 STRANDS, COLOR BROWN		
AR				16878/4E22-198	MIL-W-16878/4	WIRE, INSUL, 22 AWG, 19 STRANDS, COLOR BLACK		
AR				16878/4E22-195	MIL-W-16878/4	WIRE, TEFLON, INSULATED, TWISTED PR TYPE E22, 19 STRANDS		
AR				16878/4E22-19W	MIL-W-16878/4	WIRE, INSULATED, 22 AWG, 19 STRANDS, COLOR WHITE		

DISTRIBUTION STATEMENT

DISTRIBUTION STATEMENT LOCATION FOR ADPS PREPARED PARTS LISTS.
 FIGURE 6-31



PARTS LIST				1. DESIGN ACTIVITY			1a. CONTRACT NO.		2. CAGE CODE CURRENT ORIGINAL		3. ORG DATE YR-MO-DA		4. PL		5. REV	
				6. LIST TITLE				7. END ITEM			8. APPROVAL			9. REV AUTH NO.		10. SHEET OF SHEETS
11. ITEM OR FIND NUMBER	12. QTY REQD	13. UNIT OF MEASURE	14. CAGE CODE	15. PART OR IDENTIFYING NUMBER	16. DRAWING/DOCUMENT NUMBER	17. REV LTR	18. SHT NO.	19. NOMENCLATURE OR DESCRIPTION			20. WT UNIT OR ASSY	21. HCl or HCP	22. SUPL LIST	23. NOTES		
<div style="position: relative; height: 40px;"> PREFERRED LOCATION <div style="border: 1px dashed black; padding: 5px; display: inline-block;"> <i>DISTRIBUTION STATEMENT</i> </div> </div>																
24. LTR	25. DESCRIPTION/AUTH	26. DATE YR-MO-DA	27. APVD	24. LTR	25. DESCRIPTION/AUTH	26. DATE YR-MO-DA	27. APVD									
										28. SUP NO.	29. NEXT ASSEMBLY	30. USED ON				

DISTRIBUTION STATEMENT LOCATION FOR MANUALLY PREPARED PARTS LISTS.
FIGURE 6-32



DATA LIST			1. DESIGN ACTIVITY			1a. CONTRACT NO.	2. CAGE CODE CURRENT ORIGINAL	3. ORG DATE YR-MO-DA	4. DL	5. REV	
6. LIST TITLE				7. END ITEM		8. APPROVAL		9. REV AUTH NO.		10. SHEET OF SHEETS	
11. CAGE CORE	12. PRE- FIX CODE	13. DRAWING/DOCUMENT NUMBER	14. REV LTR	15. SHT NO.	16. NOMENCLATURE OR DESCRIPTION					NOTES	
<div style="border: 1px dashed black; padding: 5px; display: inline-block;"> <p><i>DISTRIBUTION STATEMENT</i></p> </div> <p style="margin-left: 100px;"><i>PREFERRED LOCATION</i></p>											
18. LTR	19. DESCRIPTION/AUTH	20. DATE YR-MO-DA	21. APVD	18. LTR	19. DESCRIPTION/AUTH	20. DATE YR-MO-DA	21. APVD	18. LTR	19. DESCRIPTION/AUTH	20. DATE YR-MO-DA	21. APVD

DISTRIBUTION STATEMENT LOCATION FOR MANUALLY PREPARED DATA LISTS.

FIGURE 6-32.1



INDEX LIST		1. DESIGN ACTIVITY		1a. CONTRACT NO.	2. CAGE CODE CURRENT ORIGINAL	3. ORG DATE YR-MO-DA	4. IL	5. REV			
6. LIST TITLE			7. END ITEM	8. APPROVAL		9. REV AUTH NO.	10. SHEET OF SHEETS				
11. CAGE CODE	12. LIST NUMBER	13. REV LTR	14. TITLE				15. NOTES				
<p><i>PREFERRED LOCATION</i></p> <p><i>DISTRIBUTION STATEMENT</i></p>											
16. LTR	17. DESCRIPTION/AUTH	18. DATE YR-MO-DA	19. APVD	16. LTR	17. DESCRIPTION/AUTH	18. DATE YR-MO-DA	19. APVD	16. LTR	17. DESCRIPTION/AUTH	18. DATE YR-MO-DA	19. APVD

DISTRIBUTION STATEMENT LOCATION FOR MANUALLY PREPARED INDEX LISTS.

FIGURE 6-32.2



6.15 NUCLEAR HARDNESS MARKINGS ON DRAWINGS FOR CRITICAL ITEMS AND PROCESSES.

6.15.1 Items. Where nuclear survivability requirements apply, nuclear Hardness Critical Items (HCI) are identified. All applicable drawings and parts lists shall identify individual HCIs on the drawing, and the parts list.

6.15.2 Processes. Where unclear survivability requirements apply, nuclear Hardness Critical Processed (HCPs) shall be identified on applicable drawings and parts lists.

6.15.3 Nuclear Survivability Markings.

6.15.3.1 HCI Marking. HCIs shall be identified on the drawing by the symbol shown in FIGURE 6-33a. For drawings which contain only HCIs, the HCI symbol shall be placed within the Title Block shown in FIGURE 6-33g or adjacent to, when space is limited. The HCI symbol shall also be placed at the beginning of the applicable information on the field of the drawing or adjacent to (and immediately following when possible) the applicable Part or Find number shown in FIGURE 6-33d. Drawings depicting HCIs shall be the same size letters as the Title on the field of the drawing and as shown in FIGURE 6-33g for Title Blocks except for PARAGRAPH 6.16.3.

6.15.3.2 HCP Marking. HCPs shall be identified on the drawing by the symbol shown in FIGURE 6-33b. For drawings which contain only HCPs, the HCP symbol shall be placed within the Title Block shown in Figure 6-33g or adjacent to, when space is limited. The HCP symbol shall also be placed at the beginning of the applicable information on the field of the drawing or adjacent to (and immediately following when possible) the applicable Part or Find number shown in FIGURE 6-33e. Drawing depicting HCPs shall be the same size letters as the Title on the field of the drawing and as shown in FIGURE 6-33g for Title Blocks except for PARAGRAPH 6.16.3.

6.15.3.3 HCI And HCP Combined Marking. When both HCI and HCP are applicable, they shall be identified on the drawing by the symbol shown in Figure 6-33c. For drawings which contain both HCI and HCP applicability, the combined HCI/HCP symbol shall be placed within the Title Block shown in Figure 6-33g or adjacent to, when space is limited. The combined HCI/HCP shall also be placed at the beginning of the applicable information on the field of the drawing or adjacent to (and immediately following when possible) the applicable Part or Find number shown in Figure 6-33f. Drawings depicting combined HCI/HCPs shall be the same size letters as the Title on the field of the drawing and as shown in FIGURE 6-33g for Title Blocks except for PARAGRAPH 6.16.3.

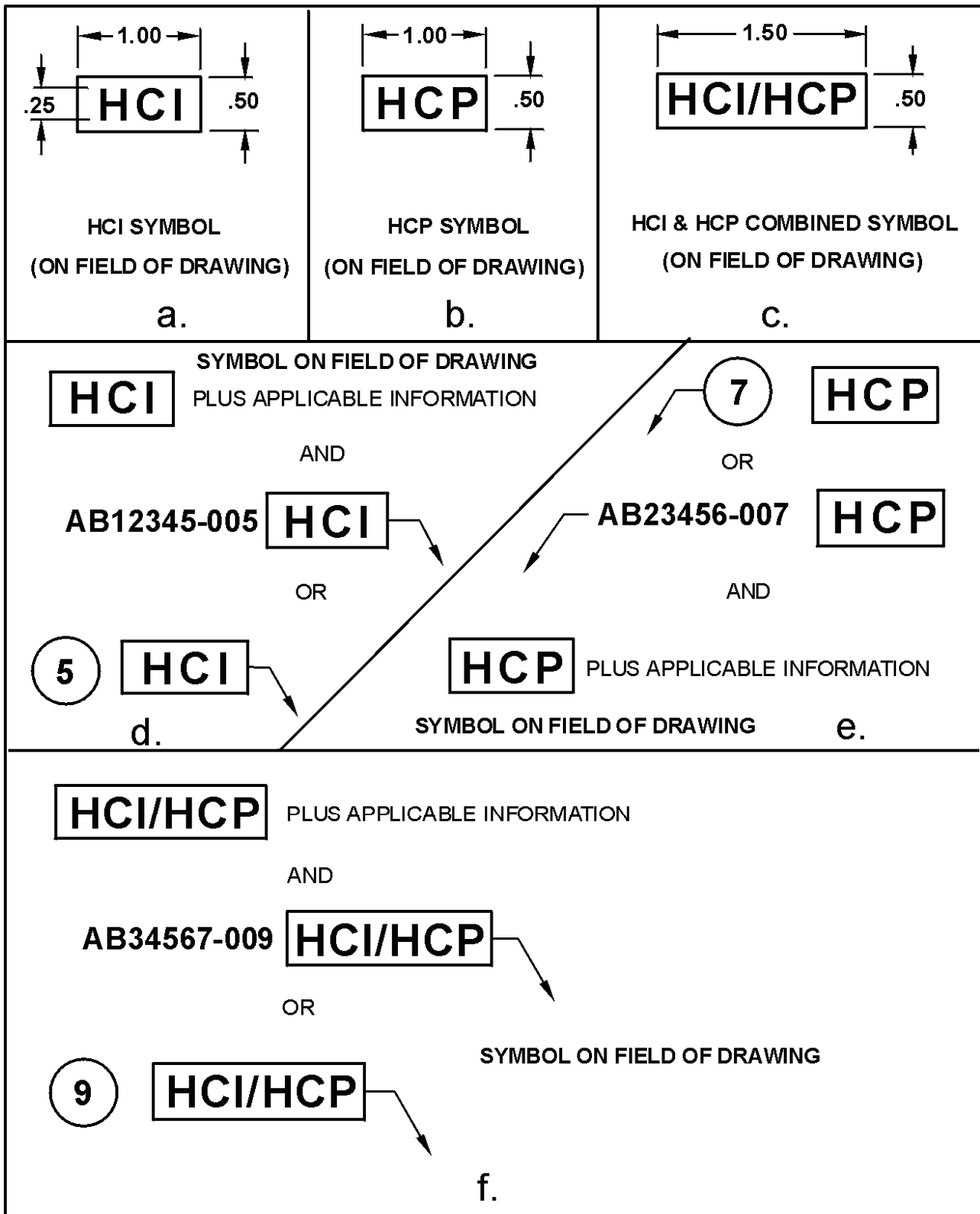
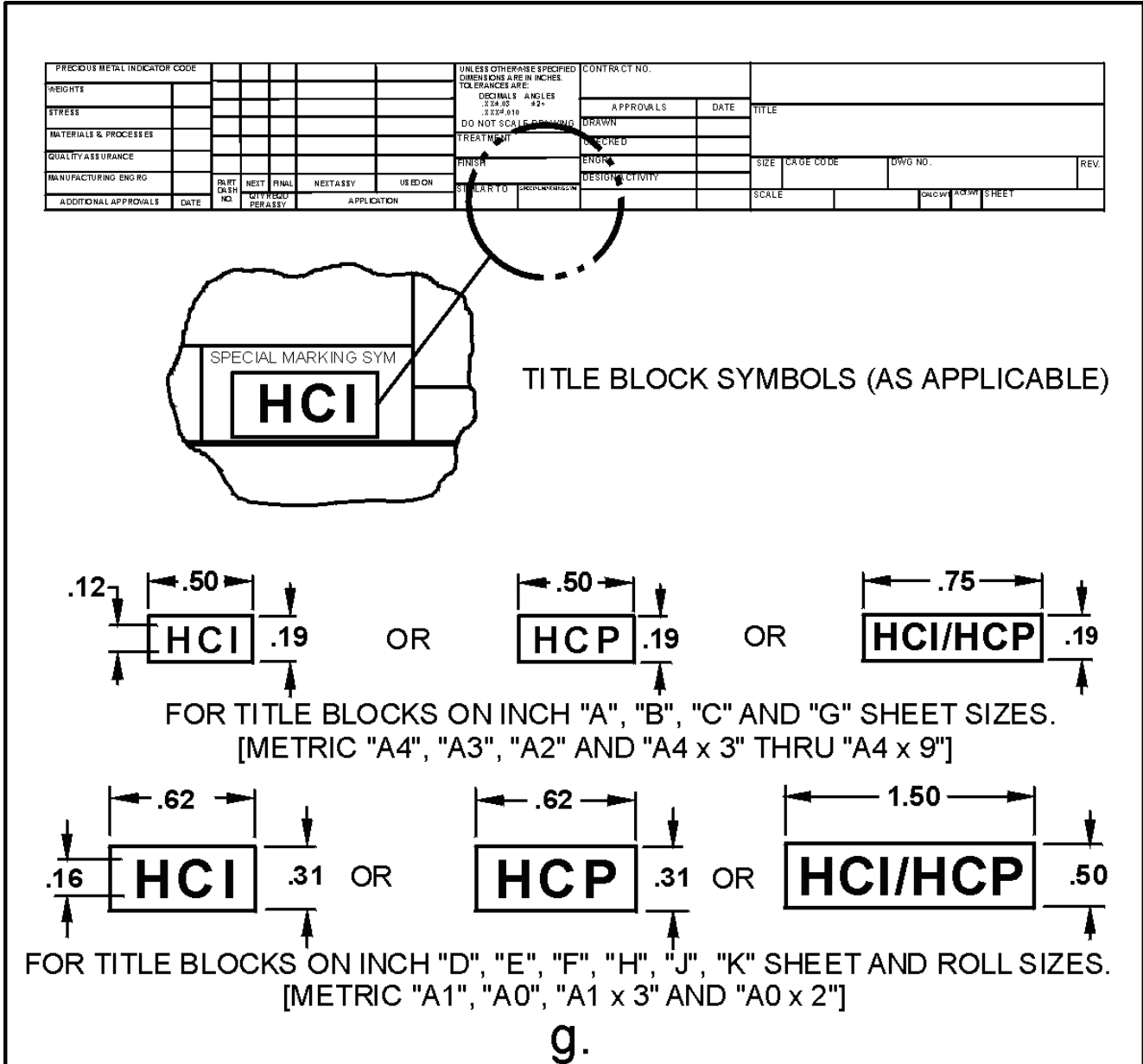

FIGURE 6-33 NUCLEAR SURVIVABILITY MARKINGS.

FIGURE 6-33 (Continued on next page.)



NUCLEAR SURVIVABILITY MARKINGS.

FIGURE 6-33 (Continued from preceding page.)

6.15.4 Mandatory Note, HCI and HCP. Any drawing or list that depicts HCIs or HCPs shall have the following note on the face of the drawing near the title block and at the foot of an associated list.

THIS (enter the word "DRAWING" or "LIST", as appropriate) DEPICTS HARDNESS CRITICAL ITEMS (HCIs) AND (OR) HARDNESS CRITICAL PROCESSES (HCPs). ALL CHANGES TO OR PROPOSED SUBSTITUTIONS OF THESE HCIs or HCPs SHALL BE EVALUATED FOR HARDNESS IMPACTS BY (enter the engineering activity responsible for nuclear survivability).



6.16 CRITICAL SAFETY ITEM (CSI) MARKINGS ON DRAWINGS.

6.16.1 Critical Safety Item Drawing. All drawings specifying information on Critical Safety Items (CSI) or Critical Safety Process (CSP) in accordance with MIL-STD-882 shall include a legend in accordance with FIGURE 6-34 above or adjacent to the title block and the following statement shall be included in the General Notes.

 CRITICAL SAFETY CHARACTERISTICS ARE INDICATED WITH THE SYMBOL CSI OR CSP

EXAMPLE:

 CSI HEAT TREAT PER _____

6.16.1.1 Exception to enclosed (boxed) Symbols. For systems which can not produce enclosed symbols, alternate symbols such as *CSI* or -CSI- in applicable text font size may be used. This applies to all enclosed symbols throughout the drawing or associated list. Exception to this rule is the ESD symbol shown in FIGURE 6-36, only that symbol shall be used in non-text applications.

EXAMPLE:

X. *CSI* HEAT TREAT PER _____

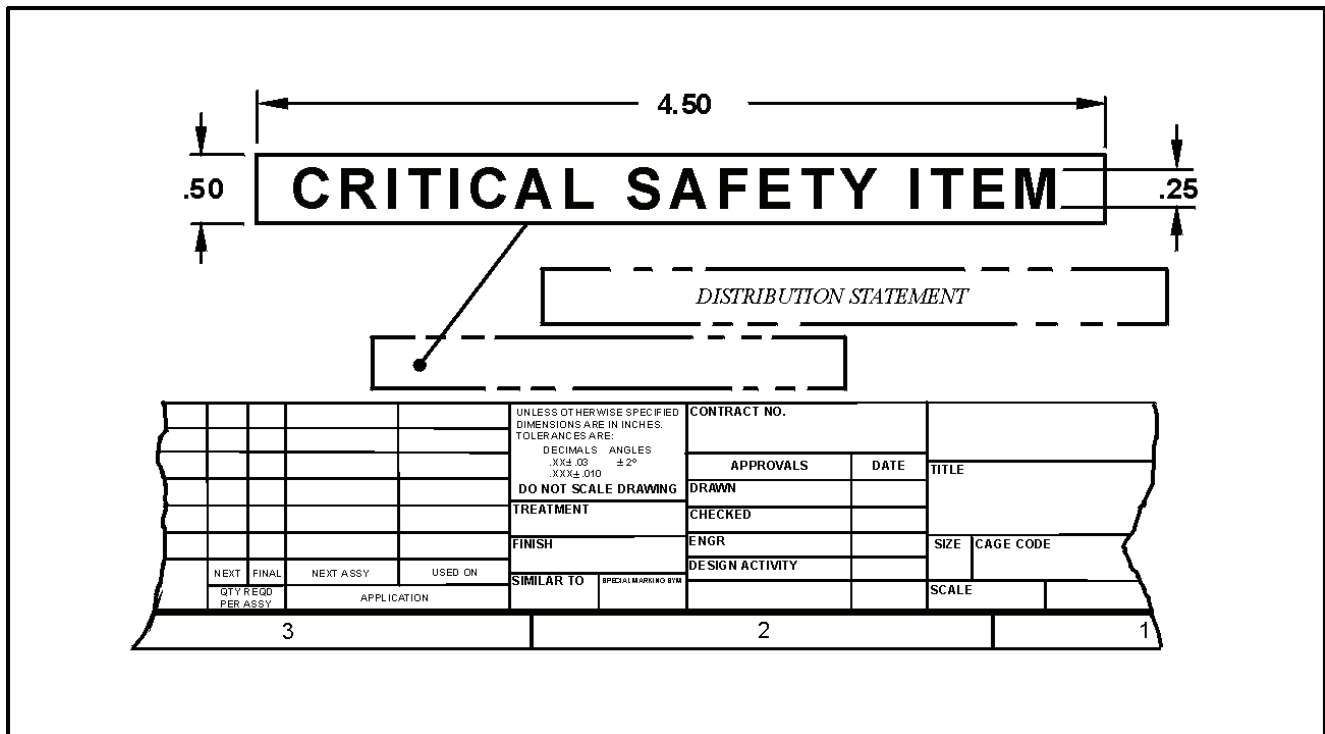

CSI DRAWING.

FIGURE 6-34



6.16.2 CSI/CSP SYMBOLS. A CSI or CSP symbol in accordance with FIGURE 6-35 shall be adjacent to each critical dimension, tolerance, process note or other Critical Safety Item Requirement.

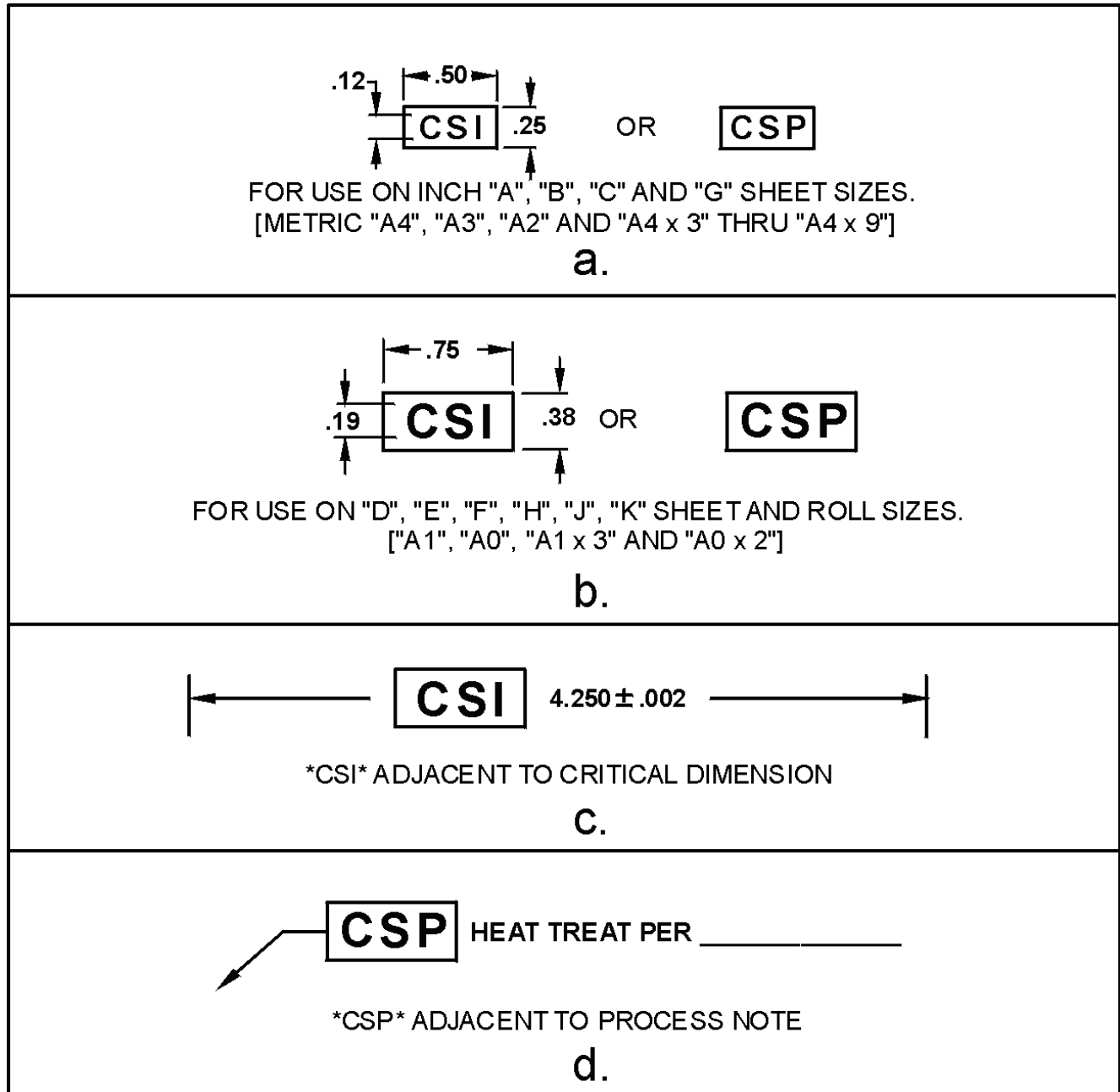

CSI/CSP SYMBOLS.
FIGURE 6-35



6.16.3 Critical Safety Note. If the critical safety characteristic is itself a note and appears only once on the drawing, the CSI symbol shall be placed at the beginning of the note as follows:

CSI A NOTE ON THE SAFETY CHARACTERISTIC
OF THE ITEM DEPICTED ON THE DRAWING.

6.16.4 Critical Safety Item Assembly. If on an assembly drawing the process or method of assembly is critical, this shall be reflected in the general drawing notes as indicated in SECTION 9.

6.17 ELECTROSTATIC DISCHARGE (ESD) PROGRAM.

6.17.1 Drawings Specifying Electrostatic Discharge (ESD) The design activity shall identify each part that shall be classified in accordance with MIL-STD-1686 and MIL-HDBK-263 for Electrostatic Discharge Control and shall include a symbol in accordance with FIGURE 6-36, placed above or adjacent to the Title Block. The use of the symbol is used to identify those solid state devices that require special handling due to electrostatic discharge.

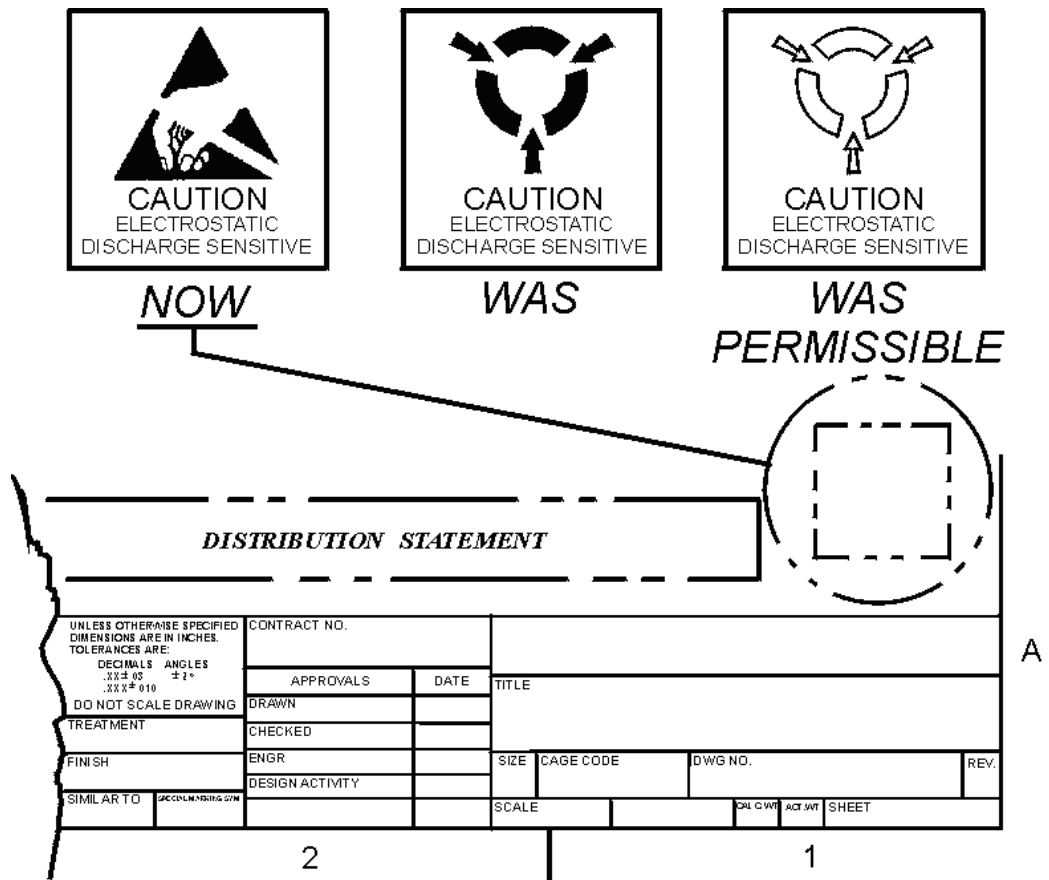

ELECTROSTATIC DISCHARGE (ESD) SYMBOL.

FIGURE 6-36



6.17.2 Location Of Electrostatic Device (ESD) Note. The following statement shall be included in the general notes and the note number identified with an applicable flag note symbol on the field of the drawing. e.g.

- X. ELECTROSTATIC DISCHARGE CONTROL (ESD) PROGRAM FOR PROTECTION OF ELECTRICAL AND ELECTRONIC PARTS, ASSEMBLIES AND EQUIPMENT SHALL BE IN ACCORDANCE WITH MIL-STD-1686, CLASS * AND MIL-HDBK-263.

** SPECIFY CLASS 1, 2, OR 3*

6.17.3 The ESD Symbol. The symbol shall be in accordance with EIA-471 as a single color reproduction in any color that contrasts with the background. The choice is arbitrary. However, the symbol be black on a yellow background is preferred. The color red should be avoided as red suggests a personal hazard. See FIGURE 6-36.1.

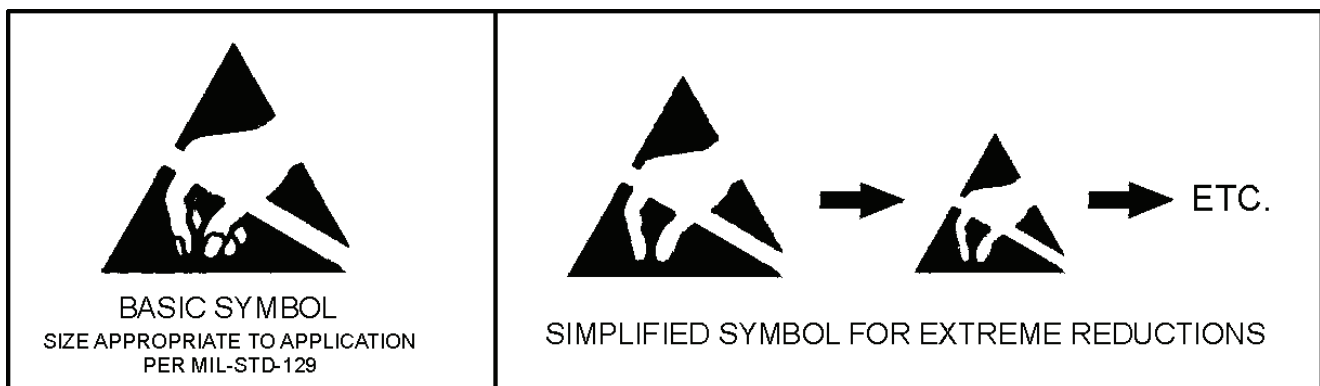

ESD SYMBOL PER EIA-471.
FIGURE 6-36.1

6.17.4 The Use of the ESD Symbol. The symbol is intended where the space available does not permit the use of the attention label described in PARAGRAPH 6.17.5. It may be used on the device if space permits, the lowest level of packaging, on device data sheets, on storage bins and on special protective wrapping materials.

6.17.5 The Use of the ESD Label. Space permitting the ESD Label is preferred to identify Electrostatic Devices as specified in FIGURE 6-36.2. An ESD caution statement should be placed adjacent to the RS-471 symbol.

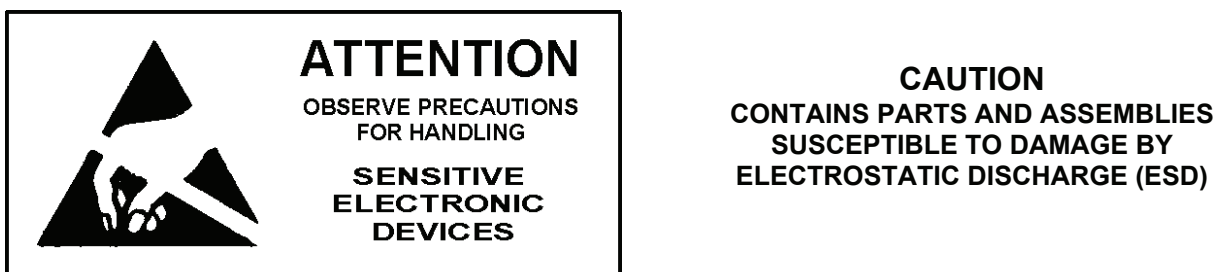

ESD LABEL PER EIA RS-471.

NOTE: Size to be appropriate to the application per MIL-STD-129.
FIGURE 6-36.2

6.18 INTERFACE CONTROL IDENTIFICATION SYMBOL MARKINGS ON DRAWINGS.

6.18.1 Drawings That Require Interface Control. Features which are identified for interface control shall be flagged with the symbol shown in FIGURE 6-37. Interface flagging shall be only as directed by the design activity. The approximate size of the symbol shall be in accordance with FIGURE 6-37.

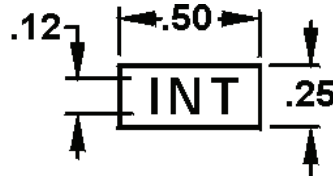

INTERFACE CONTROL SYMBOL.

FIGURE 6-37

6.18.2 Location Of Interface Control Symbol. The symbol shall be placed adjacent to the requirement if in note form and under the dimension for the feature as shown in FIGURE 6-38.

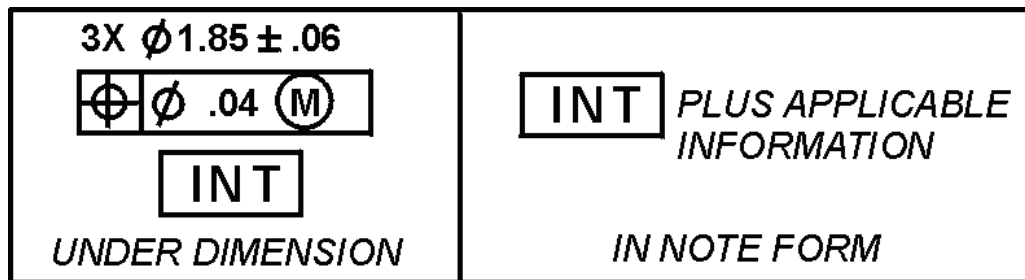

INT SYMBOL LOCATION.

FIGURE 6-38

6.18.3 Interface Dimensions, Tabulated. When interface dimensions are tabulated, the table shall include a column for entry of interface symbols next to the appropriate dimensions. See FIGURE 6-39.

SUFFIX IDENTIFIER	A	INT	B	C
-001	.125	INT	.375	1.250
-002	.375		.500	1.375
-003	.500	INT	.750	1.500

TABULATED DIMENSIONS WITH INTERFACE DIMENSIONS.

FIGURE 6-39



6.18.4 Location Of Interface Control Note. On drawings containing interface dimensioning the following shall be in the General Notes.

e.g.

#X. INT = Interface Dimensions

6.18.5 Summary and Additional "Special Items and Processes". Drawings shall identify such items, processes, or both as applicable, with specific markings, notations or both. Acronyms, descriptions, and relevant references are shown in TABLE 6-1.

*ACRONYM	DESCRIPTION	REFERENCE
CSI	Critical Safety Item	MIL-STD-882
CSP	Critical Safety Process	MIL-STD-882
ENI	ENvironmental Impact Item	**
ESD*	Electronic Sensitive Device (See FIGURE 6-36)	MIL-STD-1686/ MIL-HDBK-263
ESS	Environmental Stress Screening	MIL-HDBK-2164A
HAZ	HAZardous conditions, process or materials	**
HCI	Hardness Critical Item	**
HCP	Hardness Critical Process	**
I/R	Interchangeability/Replaceability	MIL-I-8500
INT	INTerface control	
OCI	Observable Critical Item	**
OCP	Observable Critical Process	**
ODC	Ozone Depleting Chemical	**
ODS	Ozone Depleting Substances	In conformance to Section 602 of the Clean Air Act Amds of 1990 (42 USC 7671a) as identified in Section 326 of Public Law PL 102-484

* Unless otherwise specified, Acronyms are placed within an enclosed rectangular box as shown.

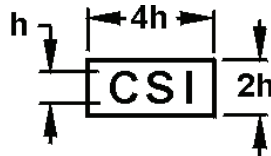

**Those symbology items and processes that are not supported by referenced published standardization documents, those items and processes shall be identified with the acronym and symbology defining the item and process on the drawing or referenced to another document prepared and supplied as part of The Technical Data Package (TDP).

***The following note is used when the use of ozone depleting substances are delineated on the drawing: THIS (enter the word DRAWING or PARTS LIST, as appropriate) IDENTIFIES THE USE OF A CLASS I OZONE DEPLETING SUBSTANCE (ODS).

ACRONYMS, DESCRIPTIONS AND REFERENCES.

TABLE 6-2



6.18.6 Variances. For systems which cannot produce the boxed symbols, and for standard text, alternate symbols such as *HCI*, -OCP-, -CSI-, or *INT*, in applicable note and text font size, may be used. The same symbology structure shall be used throughout the drawing. However, for the ESD symbol shown in FIGURE 6-36, only that symbol shall be used in non-text applications.

6.18.7 Cross-Reference of Special Tools and Jigs. On drawings of parts that require the use of special tools and jigs, the following shall be included in the general notes on both the part drawing and assembly drawing to assure consideration of the tool in the event of proposed change to the part.

X. REQUIRES SPECIAL TOOL, SEE DRAWING ABXXXXXX.

6.19 CAD (COMPUTER AIDED DESIGN) PRODUCED DRAWING MARKINGS. A new section (SECTION 26) has been added to the 11th Edition of this manual. SECTION 26 covers items including the use of 3D digital data, 3D solid model data, drawings based on digital data, correlation between the digital (model) data and the drawing, etc. Refer to SECTION 26 for more information on digital data documentation practices. If the information in SECTION 26 conflicts with the following information in Section 6.19 and sub-paragraphs, the information in SECTION 26 takes precedence. (Author's Note: I do not believe there is any conflict between these sections.)

6.19.1 Duplicate Production Master Drawings (Stable Base Artwork). One master pattern drawing shall be prepared as an original master. Duplicates of the master drawing made from the original stable base artwork or CAD system shall be marked "DUPLICATE PRODUCTION MASTER DO NOT REVISE" in the revision block area as shown in FIGURE 6-40.

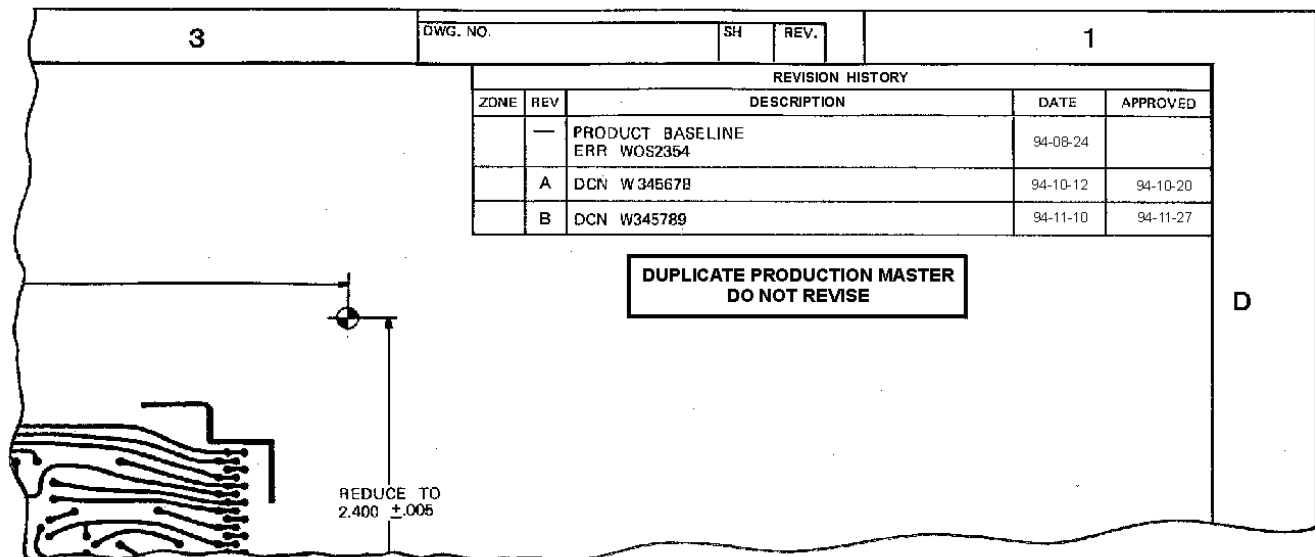

DUPLICATE PRODUCTION MASTER DRAWING NOTATION.

FIGURE 6-40



6.19.2 CAD Reproductions. Reproductions of drawings that specify the format for delivery is by the Contract Data Requirements List (CDRL) per MIL-STD-1840 and are CAD data base controlled shall be marked and maintained as digitally stored. The following note shall be placed beneath the last entry of the revision block area. See FIGURE 6-41.

DWG. NO.		SH	REV.	1	
REVISION HISTORY					
ZONE	REV	DESCRIPTION		DATE	APPROVED
	—	PRODUCT BASELINE ERR WOS 345678		94-11-15	
<p>THIS DRAWING HAS BEEN GENERATED AND IS MAINTAINED BY A CAD SYSTEM. CHANGES SHALL ONLY BE INCORPORATED AS DIRECTED BY THE DESIGN ACTIVITY.</p>					
					D

LOCATION OF CAD GENERATED DRAWING NOTE AT PRODUCT BASELINE.

FIGURE 6-41

6.19.3 Drawing Copies Derived From Exchanged Digital Data. When the digital data is exchanged between dissimilar systems, the exchange format (such as IGES or STEP) shall be included on the drawing copy inserted under the CAD entry under the Revision History Block. See FIGURE 6-42.

DWG. NO.		SH	REV.	1	
REVISION HISTORY					
ZONE	REV	DESCRIPTION		DATE	APPROVED
	—	PRODUCT BASELINE ERR WOS 345678		94-11-15	
<p>THIS DRAWING HAS BEEN GENERATED AND IS MAINTAINED BY A CAD SYSTEM. CHANGES SHALL ONLY BE INCORPORATED AS DIRECTED BY THE DESIGN ACTIVITY.</p>					
<p>IGES - (●)</p>				<p><i>INSERT IGES VERSION e.g. 5.1</i></p>	
					D

DRAWINGS DERIVED FROM EXCHANGED DIGITAL DATA.

FIGURE 6-42



6.20 PRECIOUS METAL IDENTIFICATION MARKINGS ON DRAWINGS.

6.20.1 Precious Metal Identification. When required by design or procuring activity precious metal identification shall be shown on component and part drawings. For assemblies with parts containing precious metal(s), enter appropriate code in the PMIC block within the Title Block on the Assembly Drawing. See FIGURE 6-13. Until such time a Government or Non Government standard is published for a code to identify precious metals, the precious metals codes listed in FIGURE 6-43 may be used so long as each code used shall be identified on the drawing or in the General Notes column.

6.20.2 Selecting Type Of Precious Metal. Precious metals (gold, silver, platinum, palladium, rhodium, ruthenium, osmium and iridium) shall be identified on the engineering drawing according to the Precious Metal Indicator Code (PMIC) shown in FIGURE 6-43.

6.20.3 Determining Amount Of Precious Metal. The amount of precious metal in grams shall be specified by use of the Precious Metal Indicator Code (PMIC), shown on FIGURE 6-43.

6.20.4 Location Of Precious Metal Identification And Weight. Precious metal identification shall be shown in applicable block (in title block) citing the PMIC and weight in grams (rounded off to the nearest whole number). See FIGURES 6-12 and 6-13.

e.g. The drawing notation for a part containing 6.8g of silver shall be: "E, 7 GRAMS".

6.20.5 Part Drawings Without Precious Metals Used. If the component part or assembly does not have precious metals, enter code "A" in the PMIC block within the Title Block.

6.20.6 When Use Of PMIC Is Not Applicable. For drawings such as installation drawings, interface control, schematic diagrams, non-item, etc., enter code "NA" in the PMIC block within the Title Block.



CODE	TYPE OF PRECIOUS METAL	CONTENT VALUE
CD	COMPONENT DRAWING(S) SPECIFIES TYPE	COMPONENT DRAWING(S) SPECIFIES CONTENT
NA	PMIC IS NOT APPLICABLE TO DRAWING	NOT APPLICABLE
A	NO KNOWN PRECIOUS METAL	NONE
B	ITEM IS KNOWN TO CONTAIN PRECIOUS METAL(S) BUT THE AMOUNT(S) ARE UNKNOWN	UNKNOWN
C	THE PRESENCE OR ABSENCE OF PRECIOUS METALS VARIES BETWEEN ITEMS OF PRODUCTION FOR SAME ITEM OF SUPPLY	UNKNOWN
D	SILVER	EQUALS 15 GRAMS OR MORE
E	SILVER	LESS THAN 15 GRAMS
F	GOLD	EQUALS 10 GRAMS OR MORE
G	GOLD	LESS THAN 10 GRAMS
H	PLATINUM	EQUALS 10 GRAMS OR MORE
I	PLATINUM	LESS THAN 10 GRAMS
J	PALLADIUM	EQUALS 5 GRAMS OR MORE
K	PALLADIUM	LESS THAN 5 GRAMS
L	IRIDIUM	EQUALS 20 GRAMS OR MORE
M	IRIDIUM	LESS THAN 20 GRAMS
N	RHODIUM	EQUALS 15 GRAMS OR MORE
O	RHODIUM	LESS THAN 15 GRAMS
P	OSMIUM	EQUALS 10 GRAMS OR MORE
Q	OSMIUM	LESS THAN 10 GRAMS
R	RUTHENIUM	EQUALS 10 GRAMS OR MORE
S	RUTHENIUM	LESS THAN 10 GRAMS
T	SILVER-GOLD	COMBINATION EQUALS 15 GRAMS OR MORE
U	SILVER-GOLD	COMBINATION CONTAINS LESS THAN 15 GRAMS
V	SILVER-PLATINUM FAMILY	COMBINATION EQUALS 15 GRAMS OR MORE
W	SILVER-PLATINUM FAMILY	COMBINATION CONTAINS LESS THAN 15 GRAMS
X	SILVER-GOLD PLATINUM FAMILY	COMBINATION EQUALS 15 GRAMS OR MORE
Y	SILVER-GOLD-PLATINUM FAMILY	COMBINATION CONTAINS LESS THAN 15 GRAMS
Z	GOLD-PLATINUM FAMILY	COMBINATION EQUALS 10 GRAMS OR MORE
2	GOLD-PLATINUM FAMILY	COMBINATION CONTAINS LESS THAN 10 GRAMS
3	DETERMINATION OF PRECIOUS METAL CONTENT IS UNECONOMICAL	

SEE NOTE 1

SEE NOTE 1

- Notes:
1. Platinum family included platinum, palladium, iridium, rhodium, osmium and ruthenium.
 2. When the type of precious metal is known but the content value is unknown, use the "less than 10 grams" for that metal (i.e., for gold, use Code "G"; for silver, use Code "E", etc.).
 3. When the type and amount of precious metal is unknown, use Code "B".
 4. For assembly drawings with components containing precious metal, use CD for PMIC.

PRECIOUS METALS INDICATOR CODE.

FIGURE 6-43



6.21 CHEMICAL AGENT RESISTANT COATING (CARC).

6.21.1 (CARC) Painted Items. Items coated with Chemical Agent Resistant Coating (CARC) shall have the word "CARC" and date applied near the data plate or name plate of the item. The word "CARC" shall be in contrasting color, black or green, in block letters .30 inch (7.5mm) high minimum. The marking may be applied directly or by label or decal. Drawings shall specify the exact method of applying and location of the word "CARC".

6.22 RADIATION SYMBOL MARKING ON DRAWINGS.

6.22.1 Use of Symbol. Whenever a item is exposed or involved with an actual or potential presence of ionization radiation, the radiation symbol should be displayed as prominently as is practicable.

6.22.2 Shape and Proportions of Radiation Symbol. The symbol shall be designed and proportioned to FIGURE 6-44. (ANSI N2.1)

6.22.2.1 Size of Radiation Symbol. The symbol should be of a size consistent with the size of the item. The symbol shall be identifiable from a safe distance.

6.22.3 Orientation of the Radiation Symbol. The symbol should be oriented with one blade pointed downward and centered on the vertical axis except when circumstances do not permit.

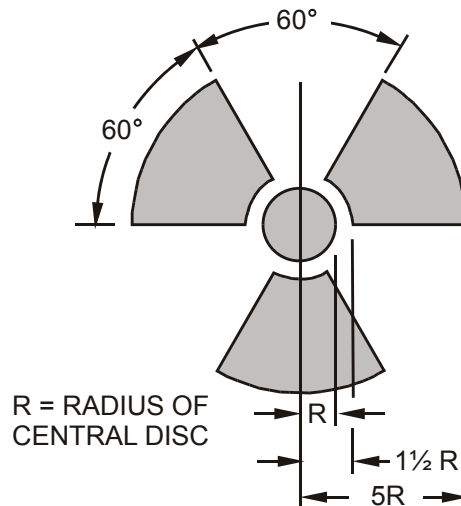

RADIATION SYMBOL

FIGURE 6-44



6.23 FISSILE MATERIAL SYMBOL MARKINGS ON DRAWINGS.

6.23.1 Use of Symbol. Whenever an item is exposed or involved with the presence of fissile material, the fissile material symbol shall be displayed as prominently as is practicable. The symbol also signifies the presence of any associated radioactive material. The basic symbol may be modified by adding the word "FISSILE".

6.23.2 Shape and Proportions of Fissile Material Symbol. The symbol shall be designed and proportioned to FIGURES 6-45a and 6-45b. (ANSI N12.1). The three blades and central disc are identical to the symbol presented in FIGURE 6-44.

6.23.2.1 Size of Fissile Material Symbol. The symbol shall be of a size consistent with the size of the item. The symbol shall be identifiable from a safe distance.

6.23.3 Orientation of the Fissile Material Symbol. The symbol should be oriented with one blade pointed downward and centered on the vertical axis except when circumstances do not permit.

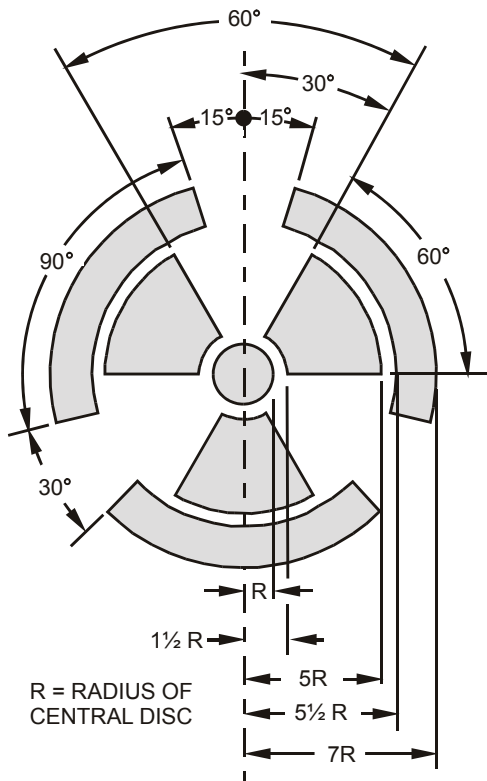

BASIC
FISSILE MATERIAL SYMBOL.
FIGURE 6-45a

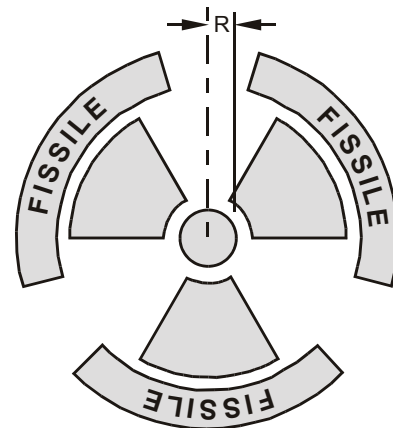

NOTE: LETTERS SHALL BE R HIGH

MODIFIED
LETTERED FISSILE MATERIAL SYMBOL.
FIGURE 6-45b



6.24 PRINT FOLDS.

6.24.1 Folding Drawing Prints. Drawing sizes "B" through "F" and roll sizes are normally folded after printing to 8 1/2 x 11 inches to fit standard-size file folders and filing cabinets. See FIGURE 6-46.

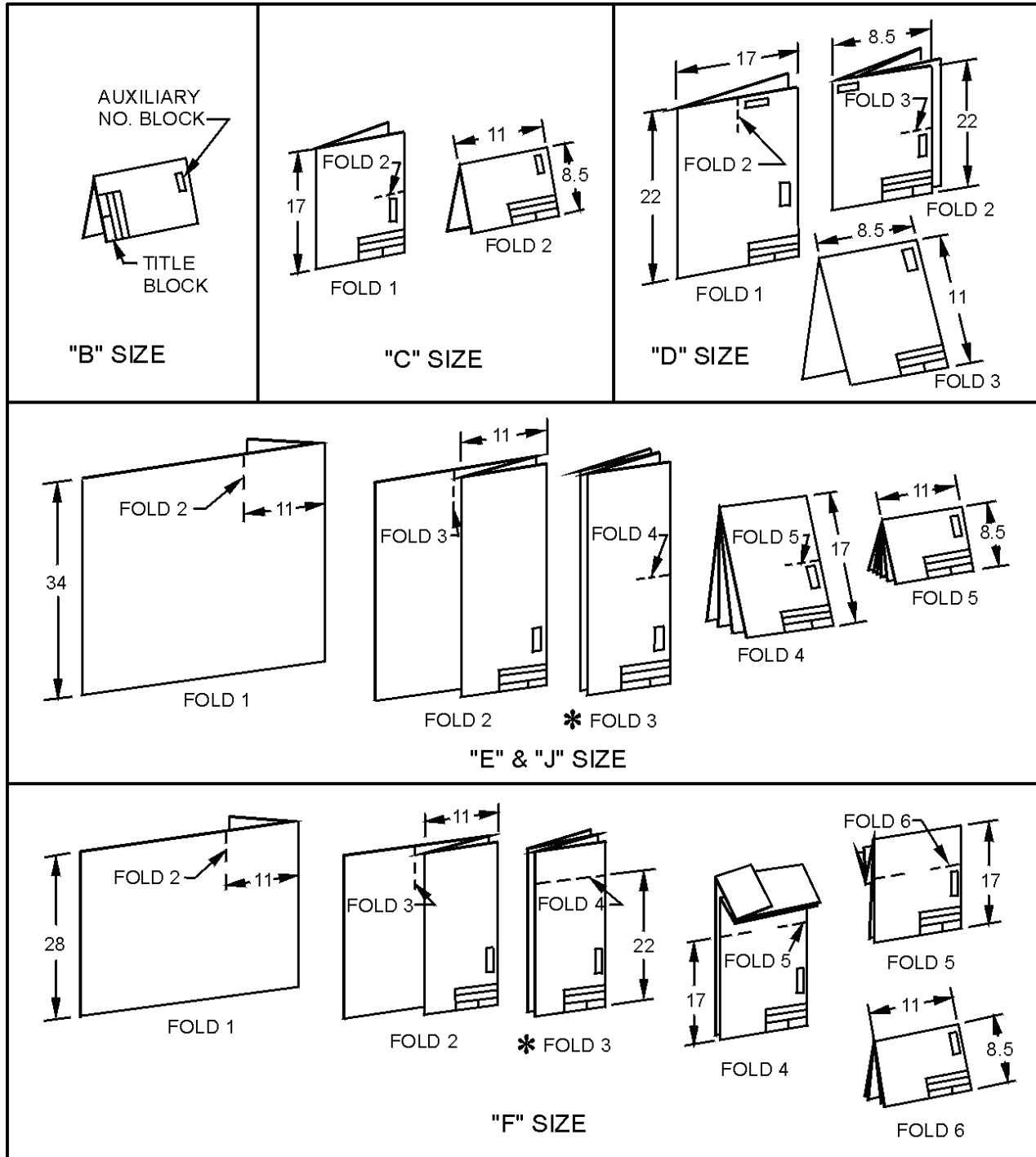

* CONTINUE TO FOLD TO END OF SHEET FOR ROLL SIZE DRAWINGS.

PRINT FOLD FOR FILING.
FIGURE 4-46



NOTES: